

Fire-Maple / 2017 / Your Mobile Kitchen



HANGZHOU LIANTU TRADING CO.,LTD
Room 2102 Tianheng Building,
No.1509 Binsheng Road, Binjiang District,
Hangzhou City, Zhejiang Prov, 310052, China

T. +86-571-82637391
F. +86-571-82635791
E. export2@fire-maple.com
W. www.fire-maple.com



Remained unchanged, fire maple has been wanting to producing good cooker products for outdoor enthusiasts
Also has not changed, we constantly inject new inspiration for our products
In 2016, our wish not changed
Hope to be able to become one of the most popular outdoor brand in China and in the world
Fire maple, picnic equipment innovators

Fire-Maple
Your Mobile Kitchen



2010

2010, Variety of novelty stoves were developed and marketed, we took these stove attend Outdoor Show in China and overseas. With ten years of hard-work and research, our development and manufacturing technology has a qualitative leap. Be worth to mentioned it, we have the honor to take Fire-Maple FMS-100T titanium stove to join the Germany ISPO Gear Prize competition, this will be the first bold attempt in the China outdoor industry. "Fire-Maple, The innovator of camping equipment" is our determination of keep developing and creation.

2011

2011 have passed with many great achievement, the birth of several leading products show the exuberant innovation ability of Fire-Maple. FMC-XX6 Hurricane heat exchanger cookware get the affirmation on market very quickly with the superior performance of increasing 30% thermal efficiency and saving 30% fuel. FMS-117T Blade titanium stove weight only 98g and got the silver medal of "The Best Outdoor Equipment" in Asia Outdoor Show. FMS-118 Volcano stove was presented in the same time. FMS-F3 Engine fuel stove got much favourite attention by its fierce fire and good applicability. Lightweight cutlery series Dandelion face to world.

2012

Fire-Maple's products has been successfully "climbed" Mount Everest on 19/05/2012, the BianBaDunZhu cartridge climbing team took FMS-118 volcano stove with FMS-G2 gas and used at Mount Everest #4 campsite(altitude 7900M) and Attack camp (altitude 8300M), At present this is the using record of highest altitude in Fire-Maple stove range.

2012

At the end of 2012, compact structure and ultralight FMS-300THornet presented to the world and got the Asia Outdoor Industry Design Award 2012.

2016

In the past year we have quickened the steps of develop variety stoves to meet with different markets request, so here it comes, the FMS-125 & FMS-126, They were both provide a wind barrier around the burner top to keep it not be affected by windy; Considering the lightweight requirements, we try to keep the concise design but more emphasized on its practicability.

2001-2002

2001-2002, Mainly OEM the camping stove and cookware for overseas brands.

2003

2003, "Fire-Maple" Brand was built up for China Market, Fire-Maple is the first local brands which focus on outdoor field.

2004-2005

2004-2005, Keep improving products and continuing attend the "China International Sporting goods" Show every year. Sponsored Xiamen University Mountaineering Team to climb the Mount KYIZI Which is 6206M. They also brought "Fire-Maple" and bannered at MUSHITAGE mountain which is 7564M, they tested the products and it performance well on the extremely environment.

2006

2006-2007, Hold the first "Outdoor Cooking Contest" and got attention & support by most outdoor enthusiasts, it enhance the impression of Fire-Maple as a local brands in the eyes of end users. At the same year, Fire-Maple was voted as the "Ten Famous Outdoor Brand" in China market. Through the market research, Our products are covered more than 70% in camping stove & cookware markets, became the leader in congeneric brand.

2008

In 2008, The first home-made titanium stove FMS-116T came in to market, weight only 48g, it is the lightest camping stove in the world. FMS-116T, such a product with new concept and technology, won many awards in outdoor equipment field, includes Asia outdoor award.

2009

In 2009, after 2 years of market research and preparatory work, the new mobile kitchen brand BLACK DEER, mainly for family traveling and self-driving tour, was launched. BLACK DEER which contains twenty kinds of products, get a first wonderful appearance in the 4th Asian International Brand sporting goods show and sports fashion expo (ISPO China). It became one of the biggest highlight on the show, and been reported by many media.

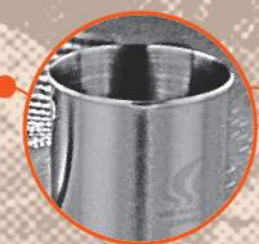

FIRE-MAPLE DEVELOPMENT HISTORY

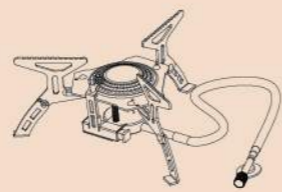

FMS-105
FOLDING GAS STOVE



FMS-116T
TITANIUM STOVE

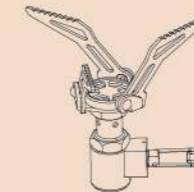

FMS-300T
MICRO STOVE

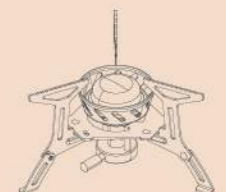

FMS-121
SPARK REMOTE WIND-RESISTANT STOVE



Come on 加油

On 12th, Aug 2013 , previous mountaineering team leader BingSun tried to climbing the "come on" route at the north wall of the Potala with his partner. This time they had to give up because the difficulty worse than expected ,three members descent safely .

photographer:alex zhao (take at the 4700M altitude campsite)

HORNET

FMS-300T MICRO STOVE



ISPO AWARD GOLD WINNER 2013

The Fire-Maple's mini stove FMS-300T called Hornet is chosen to be the gold winner of the Asian Products Division, in ISPO AWARD 2013



Fire-Maple Your Mobile Kitchen



8300M

Fire-Maple products assistant BianBaDunZhu mountaineering team successfully climbed Mount Everest on 19th of May 2012.

BianBaDunZhu climbing team took FMS-118 Volcano stove with FMS-G2 gas cartridge and used at Mount Everest #4 campsite (altitude 7900M) and Attack camp (altitude 8300M) on 19th of May 2012, At present this is the using record of highest altitude in Fire-Maple cooking range. BianBaDunZhu climbing team bought our FMS-118 Volcano stove, FMC-206 Cookware and FMS-G2 gas cartridge as their cooking gear for climbing Mount Everest; Fire-Maple products with excellent quality offer them strong logistics guarantee on the whole climbing course. We congratulated BianBaDunZhu team successfully climbed Mount Everest again; Meanwhile Fire-Maple felt glory deeply, Fire-Maple cooking equipment with the high quality refresh and towards to a new horizon.

• These photoes provided from Mr BianBaDunZhu , thanks.

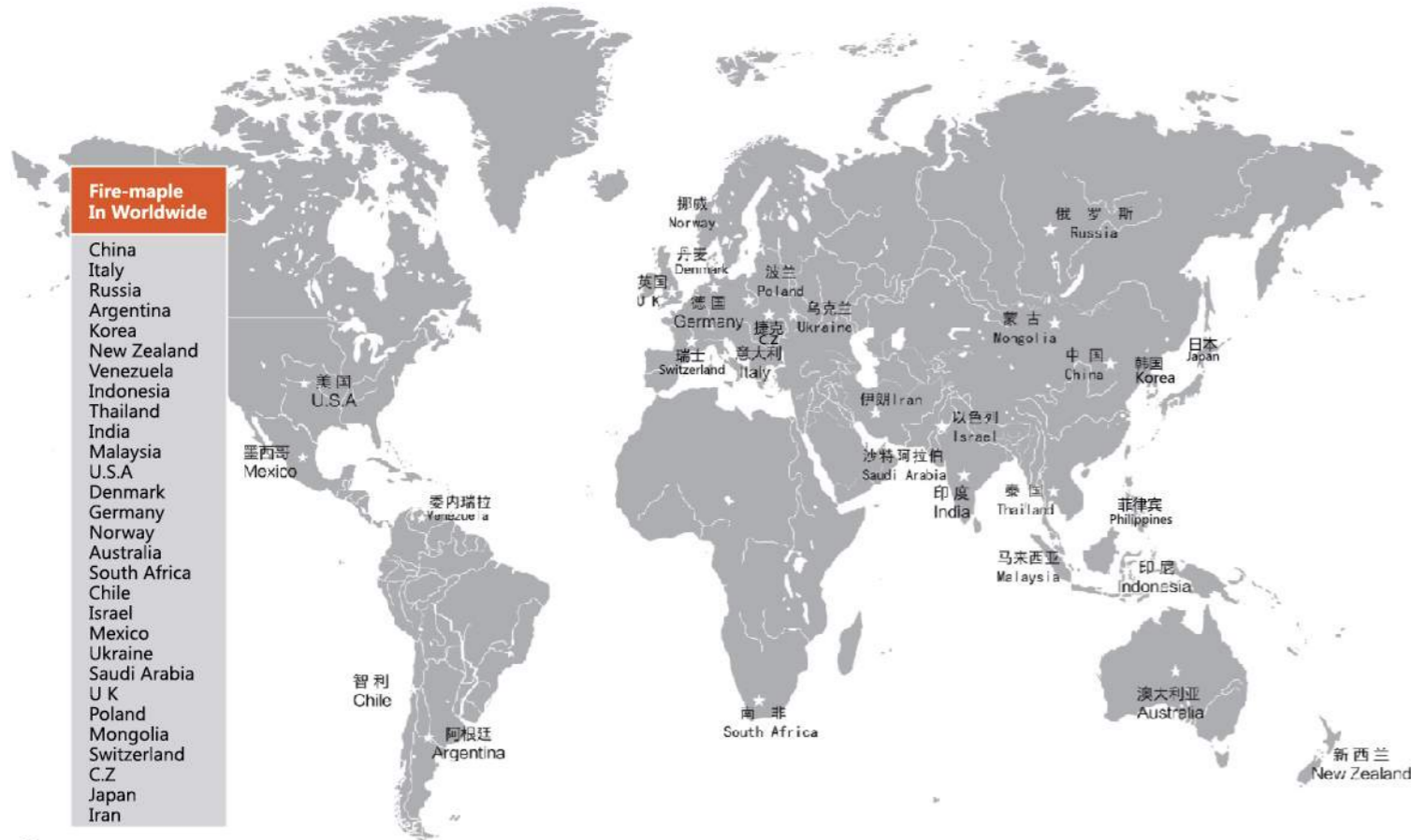

NEW PRODUCT

YOUR MOBILE KITCHEN

NEW PRODUCT



MASSIVE ROCK
FMS-123
WIND-RESISTANT STOVE

NEW PRODUCT



FMS-108
CAMPING GAS BURNER

NEW PRODUCT



STAR 2
FMS-X2 COOKING SYSTEM

NEW PRODUCT



360° Blue-Flame Blowtorch

NEW PRODUCT



FMS-121
WIND-RESISTANT REMOTE
CANISTER STOVE

2013 Outdoor Equipment
Award/Excellent
Homemade Outdoor Brand

NEW PRODUCT



FWS-02
WIND-RESISTANT REMOTE
CANISTER STOVE

NEW PRODUCT

YOUR MOBILE KITCHEN

NEW PRODUCT



Feast Rice Cooker

NEW PRODUCT



Feast Hotpot

NEW PRODUCT



FEAST K2
HEAT EXCHANGER
COOKWARE

FMB-913
ALUMINUM FOLDING TABLE



NEW PRODUCT



LEPUS
WIND-RESISTANT REMOTE
CANISTER STOVE

NEW PRODUCT



SIRIUS
WIND-RESISTANT
FOLD GAS STOVE

NEW PRODUCT



Anaconda Adaptor

NEW PRODUCT

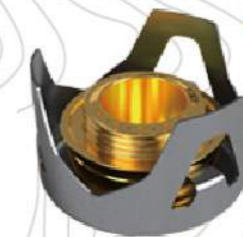

FMS-122
ALCOHOL STOVE

TITANIUM SERIES

YOUR MOBILE KITCHEN



ISPO AWARD
GOLD WINNER
2013



HORNET

FMS-300T MICRO STOVE

HEAT CORE

FMS-116T TITANIUM STOVE



KING KONG

FMS-100T TITANIUM STOVE



BLADE

FMS-117T TITANIUM STOVE



STOVE SERIES

Fire-Maple camping stove's features lightweight, small size, strong firepower, high thermal efficiency, etc. On the premise that performance remain, we undertake specific, personalized design to meet with your requirements primarily. Popularization and humanized design make Fire-Maple will be a preferred option of travel and explore enthusiasts.



■ This photos provide from fire-maple partner "LinPan climb mountain training school"

LEPUS FMS-125

WIND-RESISTANT REMOTE CANISTER STOVE



Product Specifications

Open : Ø160×76mm
Folded : Ø98×85mm
Weight : 230g
Material : Stainless steel , Aluminum , Cooper
Power : 2,600W
Boiling 1 liter water : 3'30"

Combustion Time



FMS-G3(110G)
 Approx. 36 Min.



FMS-G2(230G)
 Approx. 76 Min.



FMS-G5(450G)
 Approx. 150 Min.

SIRIUS FMS-126

WIND-RESISTANT FOLD GAS STOVE



Product Specifications

Open : Ø140×95mm
Folded : Ø70×83mm
Weight : 147g
Material : Stainless stell, Aluminum
Power : 2,500W (8,530BTU/hr)
Boiling 1 liter water : 4'06"

Combustion Time



FMS-G3(110G)
 Approx. 35 Min.



FMS-G2(230G)
 Approx. 65 Min.



FMS-G5(450G)
 Approx. 127 Min.

MASSIVE ROCK

FMS-123

Remote Wind-Resistant Stove

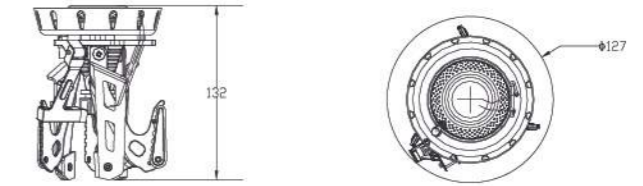
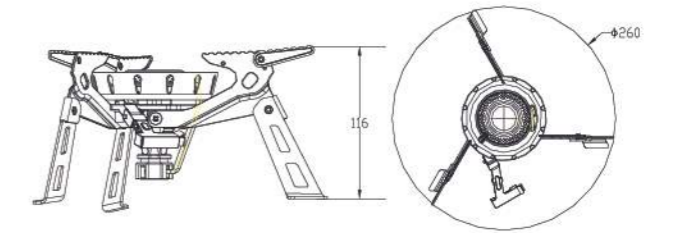

MASSIVE ROCK

FMS-123

Remote Wind-Resistant Stove

Product Specifications

Open : $\varnothing 260 \times 116 \text{mm}$
 Folded : $\varnothing 127 \times 132 \text{mm}$
 Weight : 538g

Power : 3600W
 Material : Stainless steel, Copper,
 Cast aluminum

Combustion Time



The biggest output power 3600W



FMS-G3(110G)
 Approx. 27 Min.



FMS-G2(230G)
 Approx. 57 Min.



FMS-G5(450G)
 Approx. 112 Min.

Product Introduction



- Big, bigger: stand diameter arrive 260mm can support bigger cookware



- Ignore the low temperature: with the design of the preheat tube can be normal use in a cold environment



3600W stronger power



Normal family stove power

VS

- Raging fire: 3600W stronger power like family stove

TITAN

REMOTE GAS STOVE

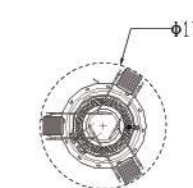
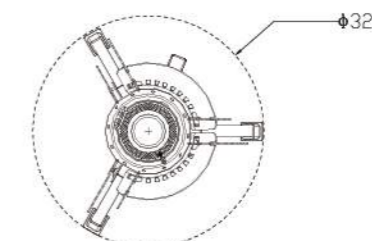
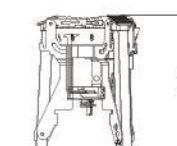
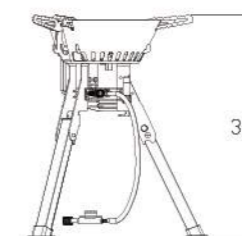

TITAN

REMOTE GAS STOVE

Product Specifications

Open : $\varnothing 329 \times 319$ mm
 Weight : 1134g
 Folded : $\varnothing 171 \times 191$ mm
 Material : Stainless steel
 Power : 4000W (13640BTU/hr)

Combustion Time



The biggest output power 4000W



FMS-G3(110G)
Approx. 24 Min.



FMS-G2(230G)
Approx. 50 Min.



FMS-G5(450G)
Approx. 97 Min.

Product Introduction



● The stove with strongest power — 4000w power, it can support self-drive camping meals under biggest power.



● Good ignition experience — Highlighting color ignition system, convenience & efficient.



● Inverted gas tank locker — Locked tank firmly, the fire power is bigger when tank inverted and performance good in high altitude and gelid.



● Air valves make sure safety, fire power regulating valve control power, it will be more safe and reliable under double security.



● Strong bracket — Improved design make bracket more stable, hand feel and drape



● Custom windshield — The ambition of delicious food wont be stopped by any bad weather

HORNET

FMS-300T MICRO STOVE

Ti



**ISPO AWARD
GOLD WINNER
2013**

The Fire-Maple's mini stove FMS-300T called Hornet is chosen to be the gold winner of the Asian Products Division, in ISPO AWARD 2013



NAN JING CHINA
Asia Outdoor Industry
Design Award 2012



户外资料网
www.8264.com
8264 2012 Outstanding
Domestic Equipment Award



HORNET

FMS-300T MICRO STOVE

Designed for professional outdoor such as long distance travelling, high altitude trekking and climbing etc. Extremely light weight Titanium stove which only weights 45 grams and the size is like a lip stick. It has unique combination of super light-weight, compact size and durability ideal for hiking and outdoors. Main material is titanium of which the feature is lightweight, high strength, thermostability and anticorrosion, it fits all requests on durability. The other materials are brass, aluminum and S/S.

1. 300T Hornet Micro Stove get the Gold winner of Asian Products Division in ISPO AWARD 2013
2. 300T Hornet Micro Stove get the winner in Asia Outdoor Industry Design Award 2012
3. 300T Hornet Micro Stove get the Outstanding Domestic Equipment Award 2012

Product Specifications

Open : Ø85×69mm
Folded : Ø37×52mm
Weight : 45g
Material : Titanium, Aluminum, Brass & S/S
Power : 2600W

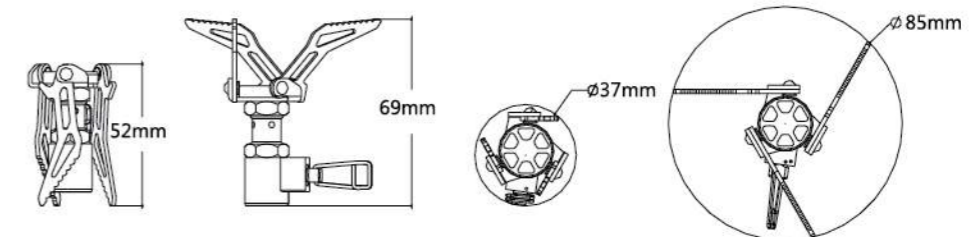

Combustion Time



Boiling 1 liter water takes only 3'50"



FMS-G3(110g) Approx. 36 Min.
FMS-G2(230g) Approx. 76 Min.
FMS-G5(450g) Approx. 150 Min.

Product Introduction



•Tiny burner top but with large spread firepower, heat well-distributed.



•Small volume and lightweight just like a lip stick, it can be put into the smallest solo pot; It's the perfect combination of super light-weight and compact size.



•Main material is titanium of which the feature is lightweight, high strength, thermostability and anticorrosion.



FMS-121
WIND-RESISTANT REMOTE
CANISTER STOVE



NEW PRODUCT
WIND-RESISTANT



2013 Outdoor Equipment
Award/Excellent
Homemade Outdoor Brand



SPARK FMS-121

WIND-RESISTANT REMOTE CANISTER STOVE

Spark wind-resistant remote stove is the best partner for outdoor chiefs. Released in 2013, Spark stove is fully wind-resistant, with innovative "Beehive™" wind-resistant net made from high temperature alloy. It can help you to cook food without any trouble lacking of wind shield. Classic design make it so easy to pack and take, unfold diameter is 18 centimeters, match with all size cook set. Amazing 2900w firepower cost it 3m35s to boil 1 liter water.

Product Specifications

Open : Ø181x95mm
Folded : Ø95x86 mm
Weight : 305 grams
Material : Stainless steel, Copper, Aluminum
Power : 2900W
Purpose: Hiking, Camping Cooking, Extreme Outdoor activities

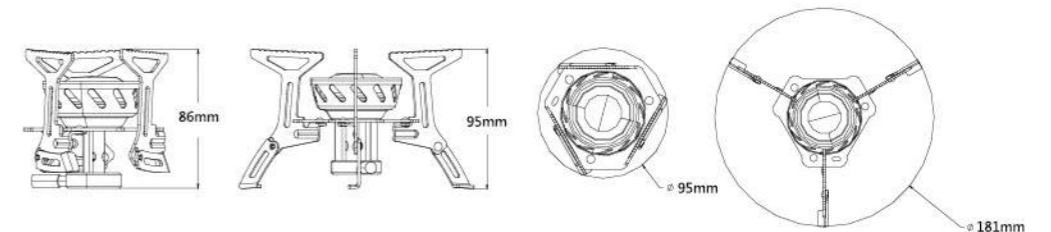

Combustion Time



| | | |
|--|--|---|
| | | |
| FMS-G3(110G) Approx. 36 Min. | FMS-G2(230G) Approx. 75 Min. | FMS-G5(450G) Approx. 145 Min. |

Product Introduction



• Classical structure design reduces the space the stove takes up.



• Copper for key components offers durability.

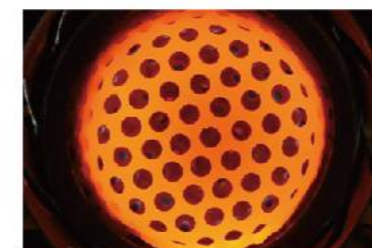

• High temperature alloy windbreak net not corrosion.



• Small figure with 2900 W power, uniform heating.



• It can resist the outdoor winds without the windshield.

ROARING FLAME

FWS-02
HIGH POWER
WIND-RESISTANT



ROARING FLAME FWS-02

WIND-RESISTANT REMOTE CANISTER STOVE

Solution always comes after the extreme weather; chilling wind can not impede our forwarding step. Fire-Maple Raging stove, brave in face of cruel weather, with a strong wind-resistant heart Raging stove was newly released in 2013 by FireMaple, be able to hold in outdoor strong windy weather, lacking of wind-shield. Innovative wind-resistant cover made from high temperature stand time. Adopting minimalist design style, Raging stove is only 255 gram, surprisingly hold up 90 kilogram. So, both solo and group camping, Raging stove will win your trust. It takes 3m35s to boiling 1 liter water by using Raging stove with 2900w maximum firepower.

Wind-Resistant : Alloy windbreak and windproof net promise the full combustion, fuel savings.

Construction : High temperature alloy windbreak design
Weight : 255grams only, meet all demand of trekking and extreme outdoor enthusiasts

Heat Power : Small figure with 2900 W power, the windproof net design offers uniform heating.

Bearing Strength : Compatible all size cook set, maximum 90KGS

Energy Saving : 3.35mins to boil 1 liter water

Package : Comes with a mesh bag for further storage



Product Specifications

Open : \varnothing 170x98 mm

Folded : \varnothing 77 x98 mm

Weight : 255 grams

Material : Stainless steel, Copper, Aluminum

Power : 2900W

Purpose : Hiking, Camping Cooking,
Extreme Outdoor activities

Combustion Time



FMS-G3(110G)
Approx. 36 Min.



FMS-G2(230G)
Approx. 75 Min.



FMS-G5(450G)
Approx. 145 Min.

Product Introduction

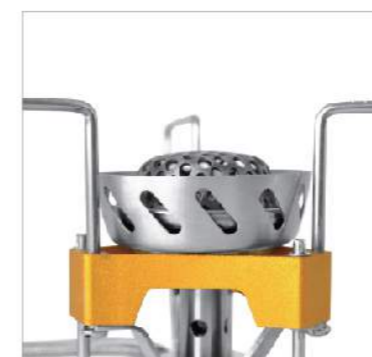

- Compatible all size cook set, maximum weight-bearing 90KGS.



- High temperature alloy windbreak net not corrosion.



- 255grams only, beyond all windproof stove of the same kind.

ENGINE

FMS-F3 FUEL STOVE

户外资料网
www.8264.com
8264 2011 Outstanding Domestic
Equipment Award



ENGINE

FMS-F3 FUEL STOVE

It uses butterfly shaped bracket, which withstand greater weight than normal legs, can be fit for various sizes of cooker, and meet single's or groups' cooking needs. The structure of FMC-F3 let it can be packed into bag and easy to carry.

Oil pump is a highlight of FMS-F3, which adopt lightweight and integrated design, weights only 47g, reducing users' load effectively. Compared with other pumps, the F3 pump made of high strength engineering plastics is more durable, can be used in various adverse outdoor environments.



Combustion Time



Boiling 1 liter water takes only 3'50"



Output 11170BTU/hr
Recommend fuel: #93 & #97 petrol

Product Specifications

Open : Ø180×180×85mm
Folded : Ø80×80×85mm
Weight : 321g
Material : Stainless Steel, Aluminum and ABS
Power : 3275W
Suitable : Extreme Explore

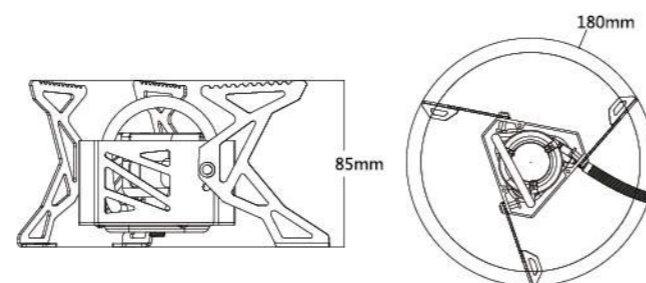

Product Introduction



• Adjusting firepower by this fire control knob.



• It uses butterfly shaped bracket, which withstand greater weight than normal legs, can be fit for various sizes of cooker, and meet single's or groups' cooking needs.



• It use with F3 stove, which adopt lightweight and integrated design, weights only 47g, reducing users' load effectively.



• It has strong firepower. In complete combustion stage, the flame was blue and no smoke. After use, no charcoal residue on the bottom of the pan.



• The pipeline of FMS-F3 adopts the latest heat-resistant and anti-oxidant rubber material, more durable.



• Come with 500ml fuel bottle lightweight and good sealing.

TURBO FMS-F5 REMOTE FUEL STOVE



TURBO FMS-F5 REMOTE FUEL STOVE

Lightweight: The lightest fuel stove in the world, suitable for any kinds of activity.
Portable: Compact and in small volume
Stability: Concise structure promise low breakdown.
 Perfect adjustment control the power very fine and smooth
 Come with lightweight pump

Provide a 330ml fuel bottle (FMS-330)
Recommend fuel: #93 & #97 petrol

Product Specifications

Open : Ø178×85mm
Folded : Ø80×85mm
Weight : 179.5g (stove), 47.7g(pump), 91.1g(330ml Fuel bottle)
Material : S/S, Aluminum, Brass
Power : 3200W

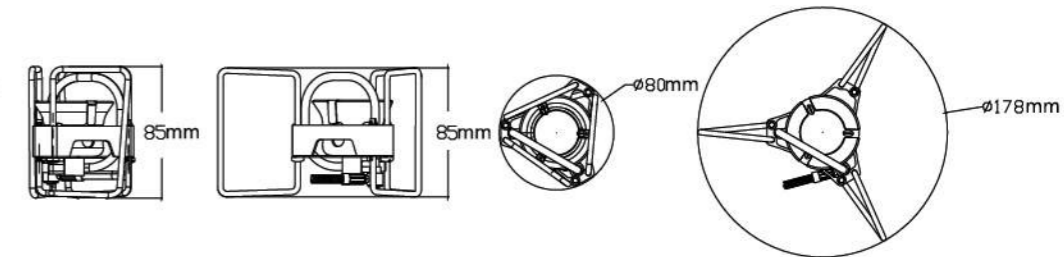

Combustion Time

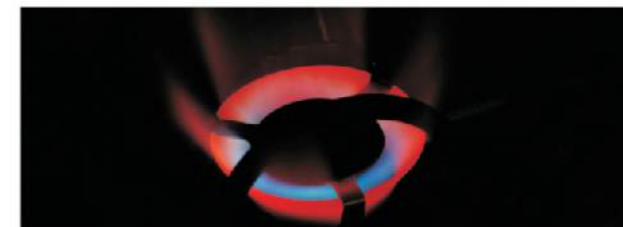

Boiling 1 liter water takes only 3'50"



FMS-B330
330ml #93 petrol (1 hour)

Product Introduction



•Concise design but with stable support legs, it can hold 80kg.



•Lightweight pump and shock resistance, the handle can be bend and will not broken.



•Come with a 330ml fuel bottle, lightweight with good sealing, it suitable for any conditions.

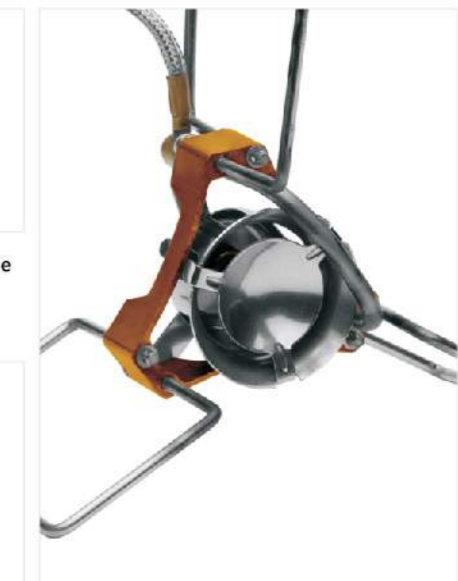

•The stove suitable for using big pot after open the support legs.



STAR 2

FMS-X2 COOKING SYSTEM

Star2 , outdoor cooking system, suitable for Extreme Explore. It equals to a large volume cup that can hold standard 230g Gas Tank, Cartridge Stand and efficient Gas Stove equipped with piezoelectric system can use more convenient.

Star2, with heat exchange on the bottom of pot, it can enhance the heat efficiently , the pot come with a heat protection cover and it prevents heat from getting out . The fixed lock handle is easy to hold.

Star2, with an independent and foldable pot holder, which is suitable for various cookers.

Product Specifications

- Open :** Ø 254mmx265mm
- Folded :** Ø 133mmx205mm
- Weight :** 600g
- Power :** 1500 W
- Load-bearing :** 5kg
- 1L Boiling water :** 3'05"
- Suitable :** Hiking, Camping Cooking, Extreme Outdoor Activities
- Material :** S/S, Brass, Aluminum & Silicon

Combustion Time



FMS-G3(110G)
Approx.66 Min



FMS-G2(230G)
Approx.138 Min



FMS-G5(450G)
Approx.270 Min

Product Introduction



• Star cooking system is an advanced and quick cooking system



• Multi-use pot holder can be suitable for various specifications cookers



• Pot designed with fixed lock handle



• X2 designed with heat exchange on the bottom of pot, it can enhance the heat more efficiently.



VOLCANO

FMS-118 GAS STOVE

The main structure of FMS-118 is made of stainless steel. Unique preheat tube and big burner top can fully heat up the gas and provide strong firepower. It's fully representation the advantages of frugality.

Big burner top make sure even firepower and let users feel more comfortable.

The design of stove are more concise, lightweight and environment friendly.

Stainless steel supporters are simple but stable and well-made, it can support big pot.

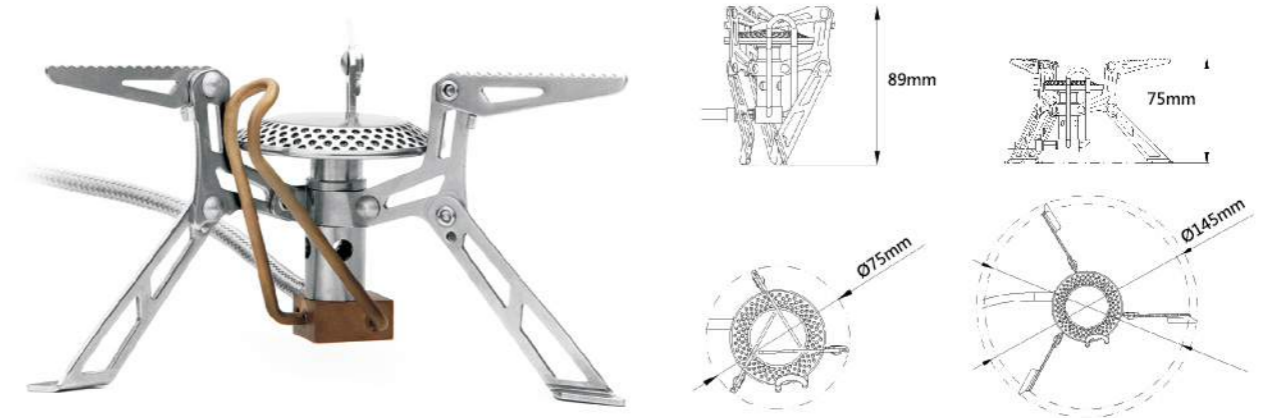

VOLCANO

FMS-118 GAS STOVE

Product Specifications

Open : Ø145x75mm
Folded : Ø75x89mm

Weight : 146g
Material : Stainless Steel
Power : 2990W

Combustion Time



Boiling 1 liter water takes only 3'20"



FMS-G3(110g)
Approx. 33 Min.

FMS-G2(230g)
Approx. 72 Min.

FMS-G5(450g)
Approx. 136 Min.

Product Introduction



•Unique preheat tube design gets the fuel burning more strong and suitable for high attitude.



•With preheat tube the stove burning more sufficient.



•Only weight 146g and easy to carrying, it covers all traveling from daily travel to extreme explore.



•Big burner top makes sure the firepower strong and give you a good cooking feeling.

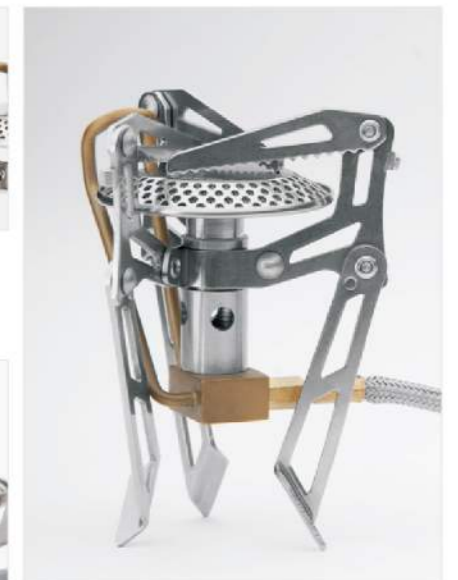

•High quality S/S support legs are simple but steady, with superior craft, it can hold large pot and use well in any kinds of cooking.



BLADE

FMS-117T TITANIUM STOVE

New design of ultralight titanium stove after our FMS-116T. The structure continue to use big burner top, match with the concise support legs based on titanium material, all these points gave 98g to this compact stove. Gas remote design, diameter of support leg is 145mm and the big burner top, all these advantage make the stove more functional.

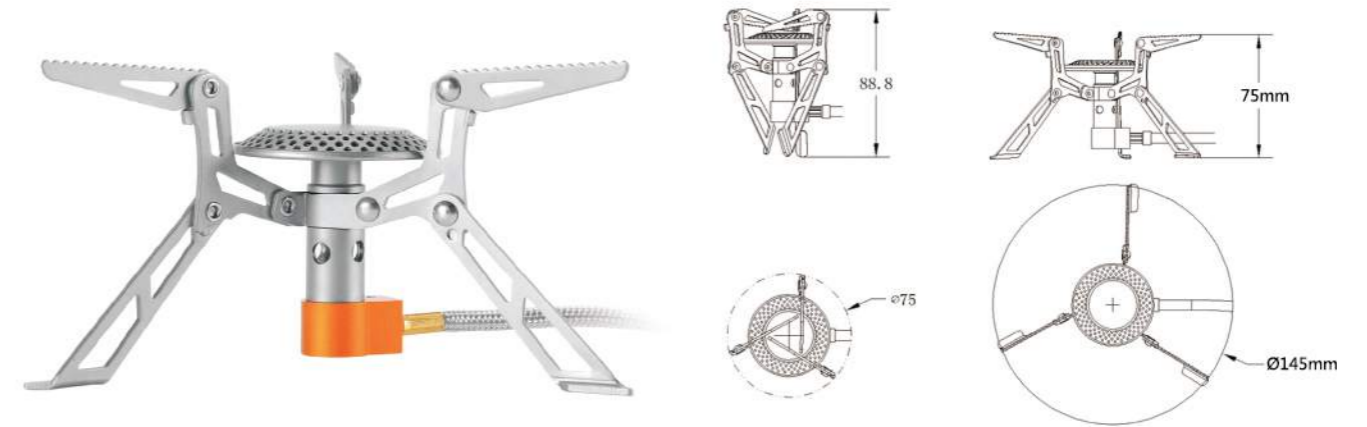

BLADE

FMS-117T TITANIUM STOVE

Product Specifications

Open : Ø145x75mm
Folded : Ø75x89mm
Weight : 98g
Material : Titanium, Aluminum and Brass
Power : 2800W

Combustion Time



Boiling 1 liter water takes only 3'25"



FMS-G3(110g) Approx. 35 Min.
FMS-G2(230g) Approx. 75 Min.
FMS-G5(450g) Approx. 144 Min.

Product Introduction



•Only weight 98g which thanks to the titanium material.



•New design of valve control made in aluminum material, it works perfect with color anodizing.



•Concise support legs, steady and durable.



•Diameter of support leg is 144.6mm with the big burner top, suitable from any environment. The power is equally distributed with big burner top and ensure the high heat efficiency.



•High strength gas tube is more light weigh and durable.



•Concise design , steady and reliable.



NAN JING CHINA

Asia Outdoor Industry Design
 Award 2011



KING KONG

FMS-100T TITANIUM STOVE

Ti

The new model of 2010.

Major body of this stove is titanium and weight is less than 200g. The design maximize the flexibility and using area. Six foldable supporting legs makes the supporting range more large and make sure it is more steady. The total metal edges remind us of the transformers.

With two-channel preheat and windscreen design, this stove promise the most efficient and sufficient combustion and provide continual fire power.

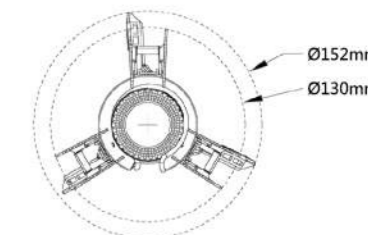
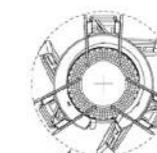
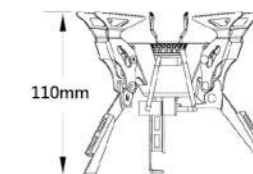

KING KONG

FMS-100T TITANIUM STOVE

Product Specifications

Open : Ø152×110mm
Folded : Ø97×70mm

Weight : 199g
Power : 2450W
Suitable : Extreme Explore

Combustion Time

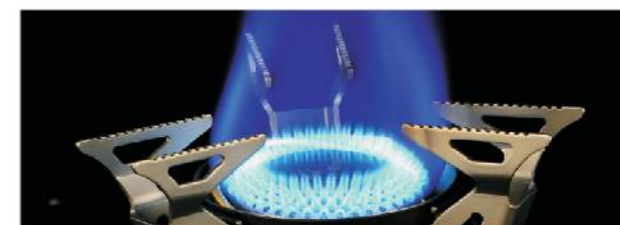

Boiling 1 liter water takes only 3'55"



FMS-G3(110g)
Approx. 38 Min.



FMS-G2(230g)
Approx. 80 Min.



FMS-G5(450g)
Approx. 155 Min.

Product Introduction



•Weight is less than 200g,more portable to carrying.



•The knob of valve can control the power exactly fine and smooth.



•Six foldable supporting legs toward to three directions, ensure supporting and stability more better when using.



•Stove body can be used as a wind-screen and it is more efficiency when burning.



•With two-channel preheat, this stove promise the most efficient and sufficient combustion and provide continual fire power.



•FMS-100T is widely suitable for any environment, ensure the function is stable in high elevation and coldest environment.



HEAT CORE

FMS-116T TITANIUM STOVE

Produced in 2009.

Inherited all the good points of FMS-116 such as big burner top and fire power, it is the perfect combination of straight flame and big burner top. The enlarging titanium support makes more stable and lighter.

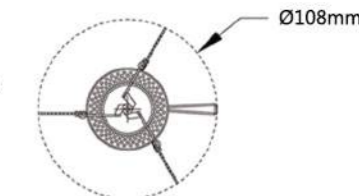
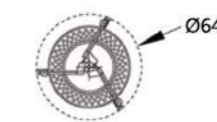
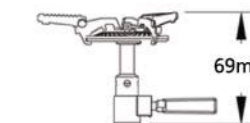
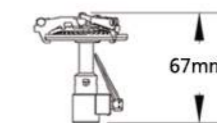

HEAT CORE

FMS-116T TITANIUM STOVE

Product Specifications

Open : Ø108×69mm
Folded : Ø64×67mm

Weight : 48g
Power : 2820W
Suitable : Extreme Explore

Combustion Time



Max output 2820W Boiling 1 liter water only takes 3'30"



FMS-G3(110g)
Approx. 35 Min.



FMS-G2(230g)
Approx. 74 Min.



FMS-G5(450g)
Approx. 145 Min.

Product Introduction



•Only weight 48g because of the titanium material



•Package is a PC box, protect the stove perfectly when take along.



•The cookware stays more stabled when cooking, as the support legs come with tooth design.



•Big burner top still keep the strong power, it's a perfect combination of straight flame and big burner top, providing the higher efficient.



•In order to reduce the size and weight, we cut the valve in round style; The whole valve design makes valve more stability and durable.



•Concise design, steady and reliable.



FMS-102 FOLDING GAS STOVE

Produced in 2003.
Compact and foldable, Made of aluminum alloy and stainless steel.
Equip piezoelectric system can light the fire successfully at one time.

Product Specifications

Open : Ø140×86mm Weight : 132g Suitable : Extreme explore
Folded : Ø61×88mm Power : 3050W

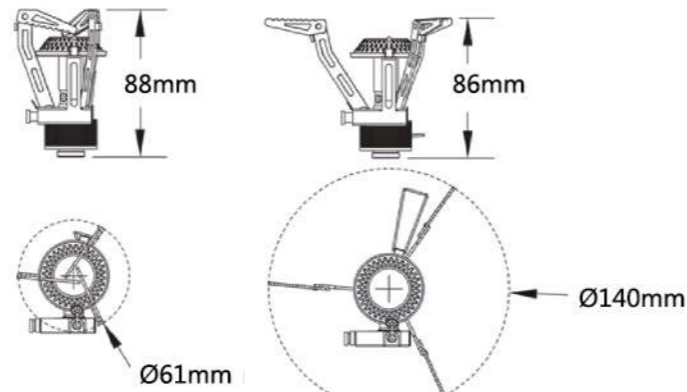

Combustion Time



Max output 3050W

Boiling 1 liter water only takes 3'25"



FMS-G3(110g)
Approx. 35 Min.

FMS-G2(230g)
Approx. 75 Min.

FMS-G5(450g)
Approx. 144 Min.

Product Introduction



•Compact and foldable, made of aluminum alloy and stainless steel, provide good supporting.

•Designed a ignition system to promise you a easy cooking life on outdoors.

•The cookware can be more stable when cooking as the support legs come with tooth design.



•Big burner top provide a strong and continuous firepower.

•Small valve with bright color design, offer you a durable and happy cooking time.

•The support legs have tooth design in order to increase the friction between pot and legs, make sure it performance well.



FMS-103 FOLDING GAS STOVE

Produced in 2003.
Simple design, easy operation & maintain. Suit for high mountain. It can withstand a strong wind by the baffle on the burner top.

Product Specifications

Open : Ø123×80mm Weight : 103g Suitable : Extreme Explore
Folded : Ø70×96mm Power : 3000W

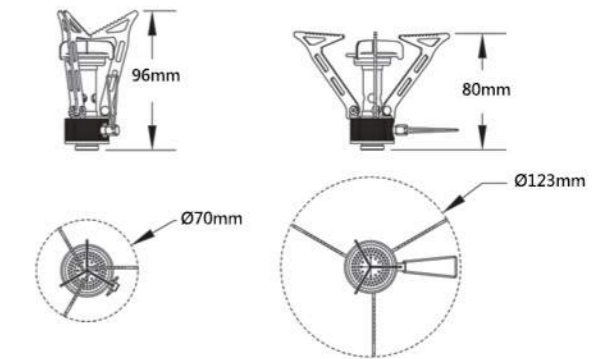

Combustion Time

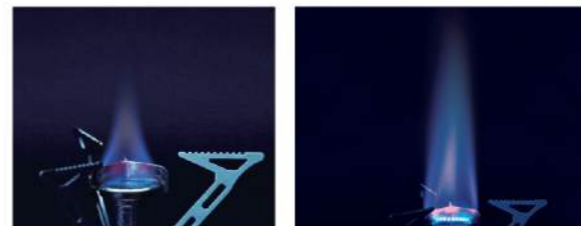

Max output 3000W

Boiling 1 liter water only takes 3'30"



FMS-G3(110g)
Approx. 31 Min.

FMS-G2(230g)
Approx. 65 Min.

FMS-G5(450g)
Approx. 127 Min.

Product Introduction

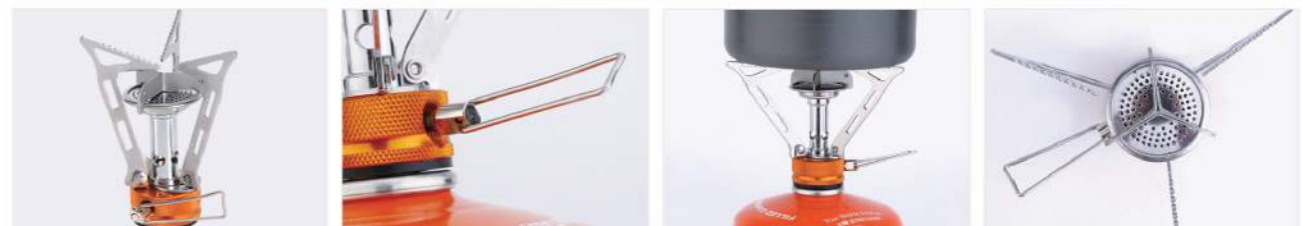

•It is brief and steady in design of structure and folding way, more steady after changed supporting style.

•Small valve with bright color design, offer you a durable and happy cooking time.

•There have 3 pieces windscreen to resist wind, with the help of windscreen design, it improves a lot on heat efficiency.

•Flat and small burner top provide a strong straight flame.



FMS-104

FOLDING GAS STOVE

Produced in 2004.
Spotless butane stove. Integrates a piezoelectric ignition with the stove that gives you high output on a steady stainless steel platform.

Product Specifications

Open : Ø220×77mm
Folded : 134×78×77mm
Weight : 235g
Power : 3200W
Suitable : Leisure & Travel

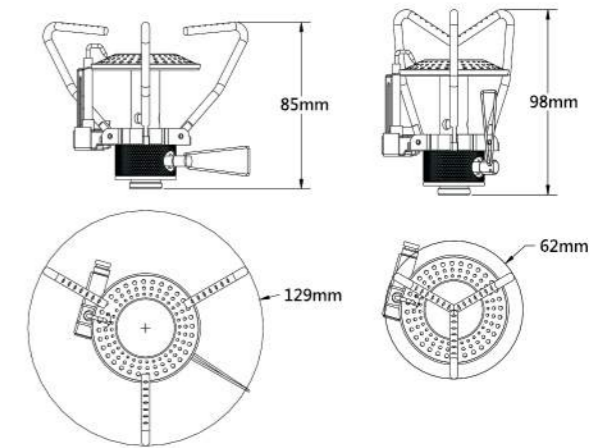
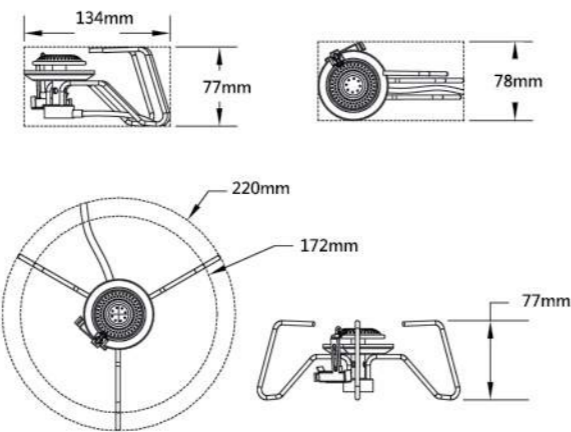

FMS-106

FOLDING GAS STOVE

Made up of 3 S/S supporter legs, very simple structure, steady support, powerful fire and precise adjustment. Small size but strong fire power, integrates a piezoelectric ignition with this burner. The support leg provide a stable support for larger cooking & folded for compact storage.

Product Specifications

Open : Ø129×85mm
Folded : Ø62×98mm
Weight : 142g
Power : 3200W
Suitable : Leisure & Travel

Combustion Time



Max output 3200W

Boiling 1 liter water only takes 3'55"



FMS-G3(110g)
Approx. 33 Min.

FMS-G2(230g)
Approx. 70 Min.

FMS-G5(450g)
Approx. 135 Min.

Combustion Time



Max output 3200W

Boiling 1 liter water only takes 3'55"



FMS-G3(110g)
Approx. 33 Min.

FMS-G2(230g)
Approx. 33 Min.

FMS-G5(450g)
Approx. 33 Min.

Product Introduction

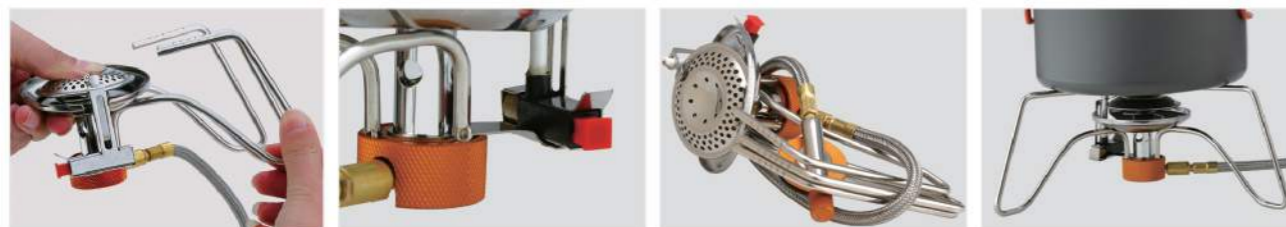

• Compact and foldable, made of aluminum alloy and stainless steel, provide good supporting.

• Designed a ignition system to promise you a easy cooking life at outdoors.

• Folding supporter can be taken down, reduce size and save space.

• There will be enough area for supporting after open support legs, the friction will be very nice with the design of groove.

Product Introduction

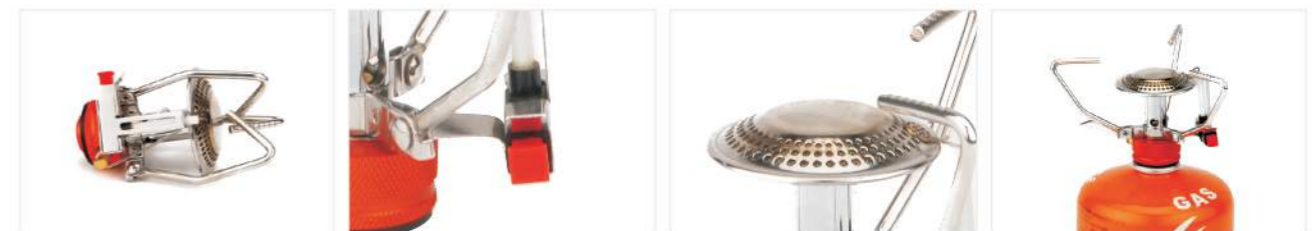

• Compact and foldable, made of aluminum alloy and stainless steel, provide good supporting.

• Designed a ignition system to promise you a easy cooking life at outdoors.

• There will be enough area for supporting after open support legs, the friction will be very nice with the design of groove.

• This stove is suitable for using bellow 4800m height.

FMS-105

FOLDING GAS STOVE

Produced in 2005.
 Unique, tough, steady and able to cook your meals in any rugged place. This stove can hold massive loads, and it will cooking very well for this stove have an ultrawide flame spreader.

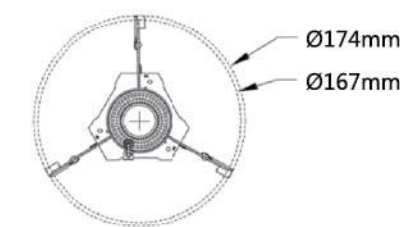
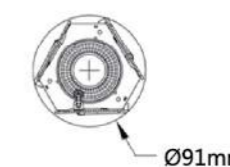
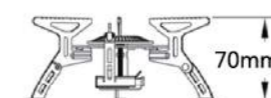
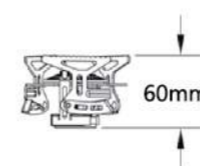

FMS-105

FOLDING GAS STOVE

Product Specifications

Open : Ø174×70mm
 Folded : Ø91×60 mm

Weight : 237g
 Power : 2600W
 Suitable : Leisure & Travel

Combustion Time



Max output 2600W



Boiling 1 liter water only takes 3'50"



FMS-G3(110g)
 Approx. 36 Min.



FMS-G2(230g)
 Approx. 75 Min.



FMS-G5(450g)
 Approx. 145 Min.

Product Introduction



•The cookware can be more stable when cooking as the support legs come with tooth design.



•Wheel adjusting knob control fire power exactly fine and smooth.



•Burner top employed a flame design in convolute way, right size and high burning efficiency, it saves fuel at a certain extent.



•Designed a ignition system to promise you a easy cooking life at outdoors.

FMS-100

CAMPING STOVE

Produced in 2009.
Six foldable supporting legs and thickening S/S ensure the supporting and steady strength.
The total metal edges remind us of the transformers. With two-channel preheat and wind-screen design, this stove promise the most efficient and sufficient combustion and provide continual fire power.



FMS-100

CAMPING STOVE

Product Specifications

Open : Ø152×110mm
Weight : 308g
Folded : Ø97×70mm
Power : 2450W
Suitable : Extreme explore

Combustion Time



Max output 2450W



Boiling 1 liter water takes only 3'20"



FMS-G3(110g)
Approx. 38 Min.



FMS-G2(230g)
Approx. 80 Min.



FMS-G5(450g)
Approx. 155 Min.

Product Introduction



- It looks like the transformers in linkage folding supporters and the angular metal texture on surface.



- The knob of valve can control the power exactly fine and smooth.



- With two-channel preheated design, this stove promise the most efficient and sufficient combustion and provide continual fire power.



- The cookware can be more stable when cooking as the support legs come with tooth design.



- Six foldable supporting legs toward to three directions, ensure supporting and stability more better when using.



- It's very small after folded and easy to take away in a pc box

FMS-116

MINI STOVE

Produced in 2007.
 Ultralight stove only weight 73g but have egregious power. In small volume, Can be put into a pot with gas canister easy.

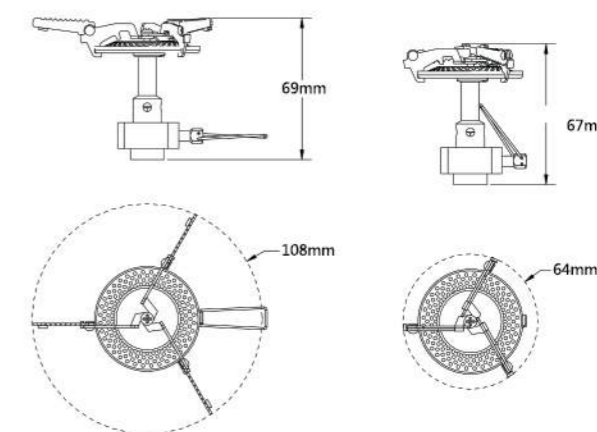

FMS-116

MINI STOVE

Product Specifications

Open : $\varnothing 108 \times 69$ mm
 Folded : $\varnothing 64 \times 67$ mm

Weight : 73g
 Power : 3000W
 Suitable : Leisure & Travel

Combustion Time



Max output 3000W

Boiling 1 liter water only takes 3'30"



FMS-G3(110g)
 Approx. 35 Min.



FMS-G2(230g)
 Approx. 74 Min.



FMS-G5(450g)
 Approx. 145 Min.

Product Introduction



•Level tooth design of support legs can increase the friction between support legs and cookware, make the cooker more stable.



•The size is tiny after folded, it can be put into pot together with gas canister easily.



•Instead of the round valve design, we use a square valve on this stove make it out of ordinary.



•We insist on using a big burner top to provide you strong and nice power.



•Concise design, steady and reliable.

FMS-706

GAS TORCH

Product Specifications

Size : Ø190×110×30mm
Weight : 159g
Power : 4400W
Suitable : Leisure & Travel

Produced in 2009.
 This product is exclusively developed for outdoor use, please make sure not to use it inside building, vehicles or tents, as there is a danger of death by asphyxiation due to carbon dioxide poisoning or oxygen deficiency. Even when using it as outdoors in narrow spaces, please make sure that there is sufficient ventilation.
 Note: Please keep children away from the torch.



Product Introduction

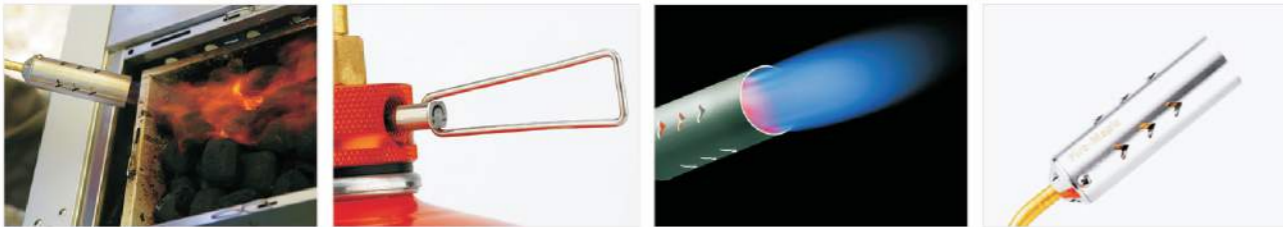

- This torch featuring as big power rate and fire power, and the temperature of the fire center can be up to 1300°C.
- Small valve with bright color design, steady and durable.
- Big S/S tube design offer you the strongest power.
- Brief design and performance perfect. Suitable for standard screw gas canister.

360° Blue-Flame Blowtorch

Product Specifications

Size : 160×35.5×55mm
Weight : 148g
Material : Stainless steel, Aluminum, ABS
Power : 2400w
Suitable : Outdoor fire, barbecue, thawing, bamboo and wood processing technology, baking cakes, etc

Fire-maple 360° Blue-Flame Blowtorch can be used on 360°, fire can be adjust small and big.
 Fire temperture can arrive 1400°C. Reference to human body engineering design of structures. Color from the color of nature.



Combustion Time

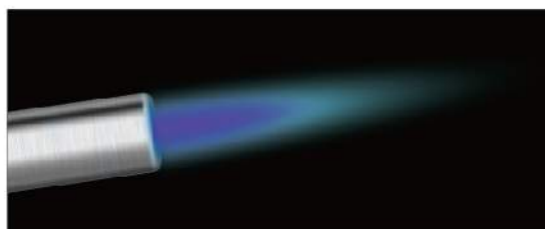

FMS-B330 FUEL BOTTLE

Product Specifications

Size : Ø66×165mm **Capacity :** 330ml **Weight :** 91.1g

Designed for FMS-F3 & FMS-F5 fuel stove, adopted high quality thicken aluminum, one body shape and large bearing design, which make the bottle more safety, durable and distortion resistance. It is also adopted specific oil rub resistance paint, which is anti-corrosion and durable.

FMS-B500 FUEL BOTTLE

Product Specifications

Size : Ø75×170mm **Capacity :** 500ml **Weight :** 126g

FMS-B750 FUEL BOTTLE

Product Specifications

Size : Ø72×250mm **Capacity :** 750ml **Weight :** 158g





BD-920

CHARCOAL GRILL

Product Specifications

Contains :
 Grill x1pc ,Cover x1pc , Gridx1pc ,
 charcoal container x1pc , bagx1pc
SIZE : 330x330x220mm 360x50x200mm
Material : Stainless steel
Weight : 1.8kg
Scope :Driving & Camping



Product Introduction



FMS-122

Alcohol Stove

NEW
PRODUCT



Simple structure of Alcohol Stove can make the alcohol vaporizing combustion and promote the burning efficiency.The supporting legs has the resistand-wind performance. Small size make it becomes the classic stove for easy taking. Whatever in outdoors for tea and indoors for cooking,it is the best helper.Also the alcohol fuel is very easy to get. Recommended:Liquid Alcohol make he burning efficiency more higher or Solid Alcohol.

Product Specifications

Specifications:
Diameter: Ø97mm
Height: 61mm
Weight: 138g
Material:Aluminum
Suitable:Leisure&Travel

Color:











| | | | |
|--|---|---|---|
|  |  |  |  |
| Olive | Grey | Bronze | Golden |



STOVE SUMMARY

| ITEM NO. | TRADE NAME | PICTURE | POWER | BOILED TIME | SPECS(MM) | WEIGHT | PAGE |
|----------|-------------------------------|---|---------------|-------------|------------------------------|--|-------|
| FMS-125 | REMOTE WIND-RESISTANT STOVE |  | 2,500W | 4'06" | Ø140×95 mm Ø70×83 mm | 147g | 17 |
| | | | 8,530 BTU/hr | | | | |
| FMS-126 | WIND-RESISTANT FOLD GAS STOVE |  | 2,600W | 3'30" | Ø160×76 mm Ø98×85 mm | 230g | 17 |
| FMS-123 | REMOTE WIND-RESISTANT STOVE |  | 3,600W | 2'50" | Ø260×116 mm Ø127×132 mm | 534g | 18-19 |
| | | | 1,2277 BTU/hr | | | | |
| FMS-108 | CAMPING GAS BURNER |  | 4,000W | 2'30" | Ø326X316 mm Ø190X200 mm | 1134g | 20-21 |
| | | | 1,3640 BTU/hr | | | | |
| FMS-300T | MINI-STOVE |  | 2,600W | 3'50" | Ø85×69mm Ø37×52mm | 45g | 22-23 |
| | | | 8,870 BTU/hr | | | | |
| FMS-121 | REMOTE WIND-RESISTANT STOVE |  | 2,900W | 3'35" | Ø181×95mm Ø95×86mm | 305g | 24-25 |
| | | | 9,895 BTU/hr | | | | |
| FWS-02 | REMOTE WIND-RESISTANT STOVE |  | 2,900W | 3'35" | Ø170×98mm Ø77×98mm | 255g | 26-27 |
| | | | 9,895 BTU/hr | | | | |
| FMS-F3 | COMPING FUEL STOVE |  | 3,275W | 3'50" | Ø180×180×85mm Ø80×80×85mm | 321g | 28-29 |
| | | | 11170 BTU/hr | | | | |
| FMS-F5 | COMPING FUEL STOVE |  | 3,200W | 3'50" | Ø178×85mm Ø80×85mm | 179.5g(stove) 47.7g(pump) 91.1g(330ml Fuel bottle) | 30-31 |
| | | | 10,918 BTU/hr | | | | |
| FMS-X2 | COOKING SYSTEM |  | 1,500 W | 3'05" | Ø254x265mm Ø133x205mm | 600g | 32-33 |
| | | | 5,115 BTU/hr | | | | |
| FMS-118 | CAS STOVE |  | 2,990W | 3'20" | Ø145×75 mm Ø75×89 mm | 146g | 34-35 |
| | | | 10,200 BTU/hr | | | | |
| FMS-117T | TITANIUM STOVE |  | 2,800W | 3'25" | Ø145×75 mm Ø75×89 mm | 98g | 36-37 |
| | | | 9,560 BTU/hr | | | | |
| FMS-100T | TITANIUM STOVE |  | 2,450W | 3'55" | Ø152×110mm Ø97×70 mm | 199g | 38-39 |
| | | | 8,350 BTU/hr | | | | |

STOVE SUMMARY

| ITEM NO. | TRADE NAME | PICTURE | POWER | BOILED TIME | SPECS(MM) | WEIGHT | PAGE |
|---------------------------|-------------------|---|---------------|-------------|-------------------------------|--------|-------|
| FMS-116T | TITANIUM STOVE |  | 2,820W | 3'30" | Ø108×69 mm Ø64×67 mm | 48g | 40-41 |
| | | | 9,620 BTU/hr | | | | |
| FMS-102 | FOLDING GAS STOVE |  | 3,050W | 3'25" | Ø140×86mm Ø61×88mm | 132g | 42 |
| | | | 10,400 BTU/hr | | | | |
| FMS-103 | FOLDING GAS STOVE |  | 3,000W | 3'30" | Ø123×80mm Ø70×96 mm | 103g | 43 |
| | | | 10,200 BTU/hr | | | | |
| FMS-104 | FOLDING GAS STOVE |  | 3,200W | 3'55" | Ø220×77mm | 235g | 44 |
| | | | 10,918 BTU/hr | | | | |
| FMS-106 | FOLDING GAS STOVE |  | 3,200W | 3'55" | Ø129×85mm Ø62×98mm | 142g | 45 |
| | | | 10,918 BTU/hr | | | | |
| FMS-105 | FOLDING GAS STOVE |  | 2,600W | 3'50" | Ø174×70mm Ø91×60 mm | 237g | 46-47 |
| | | | 8,850 BTU/hr | | | | |
| FMS-100 | CAMPING STOVE |  | 2,450W | 3'55" | Ø152×110mm Ø97×70mm | 308g | 48-49 |
| | | | 8,350 BTU/hr | | | | |
| FMS-116 | MINI-STOVE |  | 3,000W | 3'30" | Ø108×69mm Ø64×67 mm | 73g | 50-51 |
| | | | 10,200 BTU/hr | | | | |
| FMS-706 | TORCH |  | 4,400W | / | Ø190×110×30mm | 159g | 52 |
| | | | 13,600 BTU/hr | | | | |
| 360° Blue-Flame Blowtorch | TORCH |  | 2,400W | / | Ø160×35.5×55mm | 148g | 52 |
| | | | 8,189 BTU/hr | | | | |
| FMS-122 | ALCOHOL STOVE |  | / | / | Ø97x61mm | 138g | 54 |
| BD-920 | CHARCOAL GRILL |  | / | / | 330x330x220mm 360x50x200mm | 1.8kg | 55 |

Note : The testing environment is based on (standard atmospheric pressure, environmental temperature is 20°C, water temperature is 20°C, 1litre water).



COOKING SERIES

Fire-Maple,insists to select finest imported aluminum in order to fundamentally ensure the quality of our products.

With the design faith of terseness and utility,Fire-Maple cookware has become the most popular brand in domestic market.

Fire-Maple cookware with exquisite production technology,precise chemical composition,sound inspection equipment,guarantee the excellent quality and make terrific products in market.



DIFFERENT MATERIAL SHEET FOR CAMPING COOKWARE

Hardness Oxide is a kind of USA aerospace surface processing, under the temperature -10° environment, a protect layer can be formed on the aluminum alloy, this processing will have the membrance, ware-resisting, light resistance, corrosion resisting, all these ca be improved. the surface will be changed into brightness and smooth after day and day using.

| Material | Titanium | Oxide Aluminum | Stainless Steel |
|-----------------|----------|----------------|-----------------|
| Abrasive | 🔥🔥 | 🔥🔥 | 🔥🔥🔥 |
| Weight | 🔥🔥🔥 | 🔥🔥 | 🔥 |
| Heat-Conducting | 🔥 | 🔥🔥🔥 | 🔥🔥 |
| Cleaning | 🔥 | 🔥🔥🔥 | 🔥🔥 |
| Price | 🔥 | 🔥🔥 | 🔥🔥🔥 |

Normal 🔥 Good 🔥🔥 Suggestion 🔥🔥🔥



■ This photos provide from fire-maple partner "LinPan climb mountain training school"



**NEW
PRODUCT**

FEAST COOKWARE SERIES

FEAST cookware is a new conceptual casual cookware series launched by Fire-Maple in 2012. Original designs of foldable handle with dazzling color makes you at ease and comfortable.

This series is purposely designed to a variety of combinations to satisfy the needs of traveling alone or with family.



FEAST RICE COOKER



Product Specifications

Open : Ø230×253mm
Folded : Ø230×165mm
Weight : 1140g
Volumn : 3.0L

Designed to make the most delicious rice in outdoor, uniform heating cooking pot wall more thick incense, non-stick coating makes it very easy to find the cleaning, suitable for family get behind.

- Pot body and the cover is 2.7 mm thick, rice more fully heated evenly absorb water, cooked rice is full of sweet and smooth.
- Health and safety of non-stick coating, rice is not easy to anxious burnt, and convenient to clean.
- With solid stainless steel handle, outdoor use more comfortable.
- Suitable for 4 ~ 6 people.

FEAST HOTPOT



Product Specifications

Open : Ø365×131mm
Folded : Ø270×116mm
Weight : 700g
Volumn : 4.4L

Feast chafing dish bring not only the warm fish ball instant-boiled mutton but also share More friend sitting around the happy time in the night sky drink chat.

- Outdoor special hot pot, big flat sharing food more happy.
- Double folding handle is stable and reliable, receive a smaller.
- Pot body with hard oxidation technique is also easier to clean and healthy.

FEAST K2

HEAT EXCHANGER COOKWARE



FEAST K2

HEAT EXCHANGER COOKWARE



Product Specifications

Frypan : Ø168×111mm
Capacity : 1.5L
Weight : 338g
Material : Hard Anodized Aluminum

From extreme explore traveling to family camping, you will always think about this cookware, simple design but practical. New folding way with lock of handle instead of traditional design, it's unique and lovely. Vent on lid can release vapour and promise you have a more safe cooking. With heat exchange system it can improve the heat efficiency around 30% and save a lot cooking time.



FEAST XT1

HEAT EXCHANGER KETTLE



FEAST XT1

HEAT EXCHANGER KETTLE



Product Specifications

Frypan : Ø153×86mm
Capacity : 0.8L
Weight : 242g
Material : Hard Anodized Aluminum

XT1 is the best gear when you want to drink tea or coffee, bottom with heat exchange use butt joint technics and improve the heat efficiency 30%, save 30% cooking time. Control the heat inside exchanger rings, it boiling water very quickly, you can drinking at anywhere as long as you want.



FEAST XT2

HEAT EXCHANGER KETTLE

Xt2 is designed for team using, bottom with heat exchange use butt joint technics and improve the heat efficiency 30%, save 30% cooking time. Control the heat inside exchanger rings, it boiling water very quickly, you can drinking at anywhere as long as you want.

Product Specifications

Frypan : Ø153×131mm
Capacity : 1.5L
Weight : 308g
Material : Hard Anodized Aluminum



FEAST T3

BACKPACK KETTLE

Bright color design & eye-attracting, made in aluminum material with hard anodized treatment on surface, safety and healthy. The whole kettle is only weight 182g, you can put in your backpack freely, durable and easy cleaning.

Product Specifications

Frypan : Ø153×73mm
Capacity : 0.8L
Weight : 182g
Material : Hard Anodized Aluminum



FEAST T4

BACKPACK KETTLE

Bright color design & eye-attracting, made in aluminum material with hard anodized treatment on surface, safety and healthy. The whole kettle is only weight 236g. Suitable for team using.

Product Specifications

Frypan : Ø153×116mm
Capacity : 1.5L
Weight : 236g
Material : Hard Anodized Aluminum



-30%

TYPHOON

FMC-XK6 HEAT EXCHANGER POT



Product Specifications

Frypan : Ø115×135mm
Capacity : 1.0L
Weight : 190g
Material : Hard Anodized Aluminum

Use the latest butt joint technology, make the heat exchanger connect with pot more artistic and firm. Pot with heat exchange use butt joint technics, enlarge the heat range on bottom, it can increase heat efficiency rate to 30%, makes the energy use more sufficient and can save fuel consumer at a large extent, pro-environment is another strong point too.

Product Introduction



XK6
 TYPHOON With butt joint technics

 -30% Fuel

 -30% Time

 -30% Space

FEAST 1

ALUMINUM COOKWARE



Product Specifications

Frypan : Ø152×42mm
Pot : Ø146×75mm
Weight : 423g
Material : Hard Anodized Aluminum

Feast 1 is the smallest set in all Feast series, it is suitable for 1-2 people, portable and easy to carry. Bright color design always eye attracting at outdoor. New folding way of handle with lock function, it promise you good feeling on outdoor cooking. The whole set includes 1 pot, 1 frypan, 2 pp bowls, 1 sponge & 1 scoop.

FEAST 2

ALUMINUM COOKWARE



FEAST 2

ALUMINUM COOKWARE

Product Specifications

Pot : Ø168×98mm
Frypan : Ø174×42mm
Kettle(T3) : Ø153×73mm
Weight : 686g
Material : Hard Anodized Aluminum

Feast 2 suitable for 2-3 people, portable and easy to carrying. Bright color design always eye attracting at outdoor. New folding way of handle with lock function, it promise you good feeling on outdoor cooking. It come with a kettle inside, we can say it combine cooking and drinking well to meet different requests at outdoors. The whole set includes 1 pot, 1 kettle, 1 frypan, 2 pp bowls, 1 sponge & 1 scoop.



FEAST 3

ALUMINUM COOKWARE



Product Specifications

Pot(S) : Ø146×75mm

Pot(L) : Ø168×98mm

Frypan : Ø174×42mm

Weight : 706g

Material : Hard Anodized Aluminum

If you want 3 dishes and 1 soup together at one time, meanwhile you don't have so much pot come with you, Feast 3 will be your best choice. Bright color design always eye attracting at outdoor. New folding way of handle with lock function, it promise you good feeling on outdoor cooking.

The whole set includes 2 pots, 1 frypan, 2 pp bowls, 1 sponge & 1 scoop.

FEAST 4

ALUMINUM COOKWARE



FEAST 4

ALUMINUM COOKWARE

Product Specifications

Pot(S) : Ø168×98mm

Pot(L) : Ø188×118mm

Frypan : Ø194×45mm

Kettle(T3) : Ø153×73mm

Weight : 1014g

Material : Hard Anodized Aluminum

Feast 4 includes all you want, pot for cooking, kettle for drinking, it's the top choice for weekend travel and dine together, You also can take the pot out separately according to your trip.

Bright color design always eye attracting at outdoor. New folding way of handle with lock function, it promise you good feeling on outdoor cooking.

The whole set includes 2 pots, 1 kettle, 1 frypan, 2 pp bowls, 1 sponge & 1 scoop.



FEAST 5

ALUMINUM COOKWARE



Product Specifications

Pot(S) : Ø146×75mm
Pot(M) : Ø168×98mm
Pot(L) : Ø188×118mm
Frypan : Ø194×45mm
Weight : 1034g
Material : Hard Anodized Aluminum

Take one set of Feast 5 then you can solve all problems when cooking, it's the top choice for weekend travel and dine together, you also can take the pot out separately according to your trip. Bright color design always eye attracting at outdoor. New folding way of handle with lock function, it promise you good feeling on outdoor cooking. The whole set includes 3 pots, 1 frypan, 2 pp bowls, 1 sponge & 1 scoop.



FMC-K7

2-3 PERSONS COOKWARE

FMC-K7

2-3 PERSONS COOKWARE

Product Specifications

Big pot : Ø170×92mm
Small pot : Ø136×78mm
Big fry pan : Ø180×46mm
Small fry pan : Ø152×43mm
Weight : 710g
Suitable : 2-3persons

Made of aluminum with hard anodized surface, which is fire resistant and wear-resisting, easy to cleaning. And the important feature is the fry pans can be used as pot covers. The cutleries are made of PP. Including 2 fry pan, 2pots, 4 bowls, 2 spoons. Suitable for 2-3 persons.

Product Introduction

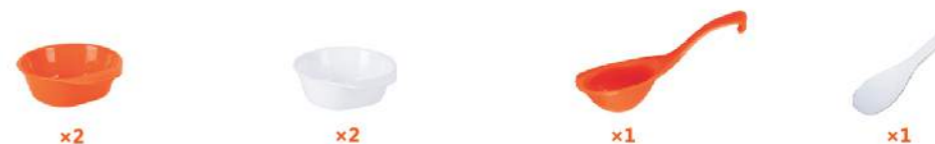

FMC-208

DOUBLE COOKWARE



FMC-208

DOUBLE COOKWARE

Ultra light and space saved, only 448g. Suit for 2-3 persons. Made of aluminum with hard anodized surface, which is fire resistant and wear-resisting, easy to cleaning. The small pot can be put into the big pot, and the small pot also can hold a gas canister and stove(Like FMS-103, FMS-116T, FMS-116)inside.

Product Specifications

- Large pot : Ø135×112mm
- Larger cover : Ø127×65mm
- Small pot : Ø125×102mm
- Small cover : Ø120×60mm
- Weight : 448g
- Suitable : 2-3 persons



FMC-201

COOKWARE

Made of aluminum material, outer surface is hard anodized and the interior is non-stick coating compound, easy to cleaning. Including 2 pots, 1 frypan, 3 bowls and 2 spoons.

Product Specifications

- Fry pan : Ø177×39mm
- M Pot : Ø170×100mm
- S Pot : Ø150×80mm
- Weight : 746g
- Suitable : 2-3 persons



FMC-202

2-3 PERSONS COOKWARE



FMC-202

2-3 PERSONS COOKWARE

Product Specifications

Fry pan : Ø177×39mm
M Pot : Ø170×100mm
S Pot : Ø150×80mm
Weight : 719g
Suitable : 2-3 persons

Made of aluminum with hard anodized surface, which is fire resistant and wear-resisting, easy to cleaning. The cutleries are made of PP. Including 1 fry pan, 2pots, 3 bowls, 2 spoons, 1 sponge. Suitable for 2-3 persons.



FMC-203

1-2 PERSONS COOKWARE

Product Specifications

Fry pan : Ø155×37mm
S Pot : Ø150×80mm
Weight : 420g
Suitable : 1-2 persons

Made of aluminum with hard anodized surface, which is fire resistant and wear-resisting, easy to cleaning. The cutleries are made of PP. Including 1 fry pan, 1pot, 2 bowls, 2 spoons, 1 sponge. Suitable for 1-2 persons.



FMC-204

2-3 PERSONS COOKWARE

Made of aluminum with hard anodized surface, which is fire resistant and wear-resisting, easy to cleaning. The cutleries are made of PP. Including 1 fry pan, 1 pot, 1 kettle, 2 bowls, 2 spoons, 1 sponge. Suitable for 2-3 persons.

Product Specifications

- Fry pan** : Ø177×37mm
- M Pot** : Ø170×100mm
- Kettle** : Ø153×67mm
- Weight** : 720g
- Suitable** : 2-3 persons



FMC-206

4-5 PERSONS COOKWARE



FMC-206

4-5 PERSONS COOKWARE

Made of aluminum with hard anodized surface, which is fire resistant and wear-resisting, easy to cleaning. The cutleries are made of PP. Including 1 fry pan, 3 pots, 5 bowls, 2 spoons, 2 dishes, 1 sponge. Suitable for 4-5 persons.

Product Specifications

- Fry pan** : Ø197×50mm
- L Pot** : Ø195×120mm
- M Pot** : Ø170×100mm
- S Pot** : Ø150×80mm
- Weight** : 1270g
- Suitable** : 4-5 persons



FMC-207

SOLO COOKWARE



Ultra light and space saved, only 195g. Suit for single use. Made of aluminum with hard anodized surface, which is fire resistant and wear-resisting, easy to cleaning. It can hold a gas canister and stove(Like FMS-103,FMS-116T, FMS-116) in pot. Including 1 pot, 1cover and 1 sponge.

Product Specifications

Pot : Ø125×102mm
Cover : Ø120×60mm
Weight : 195g
Suitable : 1 person



FMC-209

4-5 PERSONS COOKWARE

Made of aluminum with hard anodized surface, which is fire resistant and wear-resisting, easy to cleaning. The cutleries are made of PP. Including 1 fry pan, 2 pots, 1 kettle, 4 bowls, 2 spoons, 2 dishes, 1 sponge. Suitable for 4-5 persons.

Product Specifications

Fry pan : Ø197×50mm
L Pot : Ø195×120mm
M Pot : Ø170×100mm
Kettle : Ø153×67mm
Weight : 1185g
Suitable : 4-5 persons



FMC-212

6-7 PERSONS COOKWARE



FMC-212

6-7 PERSONS COOKWARE

Made of imported aluminum with hard anodized, which is fire resistant and wear-resisting, easy to clean. The cutleries are made of PP. Including 1 fry pan, 3 pots, 1 kettle, 6 bowls, 2 spoons, 3 dishes, 1 sponge. Suitable for 6-7 peoples.

Product Specifications

Fry pan : Ø218×55mm
XL Pot : Ø213×140mm
L Pot : Ø195×120mm
M Pot : Ø170×100mm
Kettle : Ø153×67mm
Weight : 1870g
Suitable : 6-7 persons



x6 x1 x3 x1 x1



FMC-213

6-7 PERSONS COOKWARE

Made of imported aluminum with hard anodized, which is fire resistant and wear-resisting, easy to clean. The cutleries are made of PP. Including 1 fry pan, 4 pots, 6 bowls, 2 spoons, 3 dishes, 1 sponge. Suitable for 6-7 peoples.

Product Specifications

Fry pan : Ø218×55mm
XL Pot : Ø213×140mm
L Pot : Ø195×120mm
M Pot : Ø170×100mm
S Pot : Ø150×80mm
Weight : 1900g
Suitable : 6-7 persons



FMC-215

COOKWARE

Product Specifications

Size : Ø277×175mm
Weight : 810g
Suitable : 6-8 persons





This large pot is designed and produced for base camp & team usage. Made of aluminum with hard anodized, which is fire resistant and wear-resisting, safe and healthy. Easy to clean. FMC-215 can be used as a hanging pot, for its high quality s/s handle, can bear weight up to 10kg. All sizes of cookware set can be nested together. Such as FMC-212 & FMC-209 etc.

Suit for team usage as driving, and family party, and outdoor team.



FMC-212 FMC-209

COOKING UTENSIL SUMMARY

| ITEM NO. | TRADE NAME | PICTURE | VOLUME | WEIGHT | SPECS(MM) | SUIT PERSON | PAGE |
|-------------------|-----------------------|---|---|--------|--|-------------|-------|
| FEAST RICE COOKER | COOKWARE |  | 3.0L | 1140g | Ø230×253mm Ø230×165mm | 4-6 | 63 |
| FEAST HOTPOT | COOKWARE |  | 4.4L | 700g | Ø365×131mm Ø270×116mm | 6-8 | 64 |
| FEAST K2 | COOKWARE |  | 1.5L | 338g | Ø168×111mm | 1 | 65 |
| FEAST XT1 | HEAT EXCHANGER KETTLE |  | 0.8L | 242g | Ø153×86mm | 1 | 66 |
| FEAST XT2 | HEAT EXCHANGER KETTLE |  | 1.5L | 308g | Ø153×131mm | 1 | 67 |
| FEAST T3 | KETTLE |  | 0.8L | 182g | Ø153×73mm | 1 | 67 |
| FEAST T4 | KETTLE |  | 1.5L | 236g | Ø153×116mm | 1 | 67 |
| FMC-XK6 | HEAT EXCHANGER POT |  | 1L | 190g | Ø115×135mm | 1 | 68-69 |
| FEAST 1 | COOKWARE |  | Pot : 0.9L Frypan : 0.5L | 423g | Pot : Ø146×75mm Frypan : Ø152×42mm | 1-2 | 70 |
| FEAST 2 | COOKWARE |  | Pot : 1.5L Fry Pan : 0.7L Kettle(T3) : 0.8L | 686g | Pot : Ø168×98mm Fry Pan : Ø174×42mm Kettle(T3) : Ø153×73mm | 2-3 | 71 |
| FEAST 3 | COOKWARE |  | Pot(S) : 0.9L Pot(L) : 1.5L Frypan : 0.7L | 706g | Pot(S) : Ø146×75mm Pot(L) : Ø168×98mm Frypan : Ø174×42mm | 2-3 | 72 |
| FEAST 4 | COOKWARE |  | Pot(L) : 2.5L Pot(S) : 1.5L Fry Pan : 0.9L Kettle(T3) : 0.8L | 1014g | Pot(L) : Ø188×118mm Pot(S) : Ø168×98mm Fry Pan : Ø194×45mm Kettle(T3) : Ø153×73mm | 4-5 | 73 |
| FEAST 5 | COOKWARE |  | Pot(L) : 2.5L Pot(M) : 1.5L Pot(S) : 0.9L Fry Pan : 0.9L | 1034g | Pot(L) : Ø188×118mm Pot(M) : Ø168×98mm Pot(S) : Ø146×75mm Fry Pan : Ø194×45mm | 4-5 | 74 |
| FMC-K7 | COOKSET |  | Big Pot : 1.7L Big Fry Pan : 0.9L Small Fry Pan : 0.6L | 710g | Big Pot : Ø170×92mm Small Pot : Ø136×78mm Big Fry Pan : Ø180×46mm Small Fry Pan : Ø152×43mm | 2-3 | 75 |

COOKING UTENSIL SUMMARY

| ITEM NO. | TRADE NAME | PICTURE | VOLUME | WEIGHT | SPECS(MM) | SUIT PERSON | PAGE |
|----------|------------|---|---|--------|--|-------------|------|
| FMC-208 | COOKWARE |  | Large Pot : 1.3L Larger Cover : 0.7L Small Pot : 0.9L Small Cover : 0.5L | 448g | Large Pot : Ø135×112mm Larger Cover : Ø127×65mm Small Pot : Ø125×102mm Small Cover : Ø120×60mm | 2-3 | 76 |
| FMC-201 | COOKWARE |  | Fry Pan : 1.7L M Pot : 1.1L S Pot : 0.7L | 746g | Fry Pan : Ø177×39mm M Pot : Ø170×100mm S Pot : Ø150×80mm | 2-3 | 77 |
| FMC-202 | COOKWARE |  | Fry Pan : 1.7L M Pot : 1.1L S Pot : 0.7L | 719g | Fry Pan : Ø177×39mm M Pot : Ø170×100mm S Pot : Ø150×80mm | 2-3 | 78 |
| FMC-203 | COOKWARE |  | S Pot : 1.1L Fry Pan : 0.6L | 420g | Fry Pan : Ø155×37mm S Pot : Ø150×80mm | 1-2 | 79 |
| FMC-204 | COOKWARE |  | M Pot : 1.7L Fry Pan : 0.7L Kettle : 0.8L | 720g | M Pot : Ø170×100mm Fry Pan : Ø177×37mm Kettle : Ø153×67mm | 2-3 | 80 |
| FMC-206 | COOKWARE |  | L Pot : 2.7L M Pot : 1.7L S Pot : 1.1L Fry Pan : 1L | 1270g | Fry Pan : Ø197×50mm L Pot : Ø195×120mm M Pot : Ø170×100mm S Pot : Ø150×80mm | 4-5 | 81 |
| FMC-207 | COOKWARE |  | Pot : 0.9L Cover : 0.5L | 195g | Pot : Ø125×102mm Cover : Ø120×60mm | 4-5 | 82 |
| FMC-209 | COOKWARE |  | Fry Pan : 2.7L L Pot : 1.7L M Pot : 1L Kettle : 0.9L | 1185g | Fry Pan : Ø197×50mm L Pot : Ø195×120mm M Pot : Ø170×100mm Kettle : Ø153×67mm | 4-5 | 83 |
| FMC-212 | COOKWARE |  | Fry Pan : 4.2L XL Pot : 2.7L L Pot : 1.7L M Pot : 1.5L Kettle : 0.8L | 1870g | Fry Pan : Ø218×55mm XL Pot : Ø213×140mm L Pot : Ø195×120mm M Pot : Ø170×100mm Kettle : Ø153×67mm | 6-7 | 84 |
| FMC-213 | COOKWARE |  | Fry Pan : 4.2L XL Pot : 2.7L L Pot : 1.7L M Pot : 1.5L S Pot : 1.8L | 1900g | Fry Pan : Ø218×55mm XL Pot : Ø213×140mm L Pot : Ø195×120mm M Pot : Ø170×100mm S Pot : Ø150×80mm | 6-7 | 85 |
| FMC-215 | COOKWARE |  | 8L | 810g | Ø277×175mm | 6-8 | 85 |

SINGLE USING

FMS-X2 + FMS-G2



FMS-X2+FMS-G2

3-4PERSONS USING

FMC-206 + FMS-F3



FMC-206



FMS-F3

SINGLE USING

HORIZON 1 + FMS-300T + FMS-G3



HORIZON 1



FMS-300T



FMS-G3

4-5PERSONS USING

FMC-212 + FMS-108



FMC-212



FMS-108

2-3PERSONS USING

FEAST 3 + FMS-F5



FEAST 3



FMS-F5

6-8PERSONS USING

FMC-215 + FMS-108



FMC-215



FMS-108



CUTLERY SERIES

The camping cutlery series are light in weight,small in volume and foldable in design,they are very convenient to carry.
The adoption of stainless steel and titanium alloy,ensuring the safety and durability of the products.



NEW
PRODUCT

FMB-913

ULTRALIGHT FOLDABLE TABLE-CICADA WINGS

Like Cicada's wings, this foldable aluminum table is very light in weight, the extreme simple design provides both stability and lightweight.

Ultralight : weighs only 388g, like Cicada Wings
Small : very small size after folding, suitable for carry everywhere in a backpack

Simple : only 4 parts, very easy to assemble

Convenient : packed in a lightweight bag

Product Specifications

Size : 360x250x100mm(unfolded)
 360x125x40mm(folded)

Weight : 388g(net)
 426g(with outer bag)

Material : hard anodized aluminum(the table board)
 Stainless Steel(the legs)

Load-bearing : 15Kg

Suitable : Leisure Travel

Product Introduction



• Hard anodized surface, very tough and not easy to scrub



• Only takes 15 seconds for a single person to assemble



• Simple design, even a girl can operate

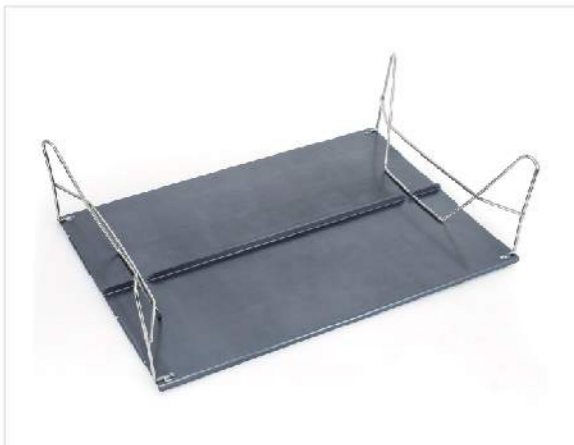

• S/S legs, can bear 15KG



• Only 40mm of thickness after folding, easy to put into a backpack, packed in a lightweight bag.

FMT-837

THREE-PIECE SET SHORT VERSION

The whole set use the 304 stainless steel(Medical Grade), very good to health, suitable for daily use and outdoor environment

NEW
PRODUCT

FMT-838

THREE-PIECE SET LONG VERSION

The whole set use the 304 stainless steel(Medical Grade), very good to health, suitable for daily use and outdoor environment

NEW
PRODUCTNEW
PRODUCT

Product Specifications

Spoon :

Size : 132x37mm

Weight : 18g

Fork :

Size : 132x37mm

Weight : 16g

Chopsticks :

Size : 122x7mm(folded)

205mm (unfolded)

Weight : 24g



Product Specifications

Spoon :

Size : 160x37mm

Weight : 27g

Fork :

Size : 160x37mm

Weight : 23g

Chopsticks :

Size : 190x6mm

Weight : 15g



FMS-710

CANISTER STAND

This stand can be put into Fire-Maple's cooking system-FMS-X1 after folding, and it can use with Fire-Maple's G2/G3/G5 gas canister, which makes the cooking more stable. Besides, it is suitable for any other cooking system.

Product Specifications

Size : Ø215x21mm(unfolded)
 Ø108x21mm(folded)

Height : 21mm

Weight : 30g

Material : ABS

Suitable : Leisure Travel



FMP-301

S/S PORTABLE CUP

Made of stainless steel, double-wall cup body with folding s/s wire handle. It has good heat-insulating property. It takes a PP cover, and the body surface is shine finished.

Product Specifications

Size : Ø70×79mm Weight : 115g Volume : 220ml



FMP-302

S/S FLEXIBLE MUG

Made of stainless steel. The flexible cup body with shine finished surface.

Product Specifications

Size : Ø65×35mm Weight : 105g Volume : 140ml



FMP-303

S/S PORTABLE CUP

Made of stainless steel, double-wall cup body with folding s/s wire handle. It has good heat-insulating property. It takes a PP cover, and the body surface is shine finished.

Product Specifications

Size : Ø82×92mm Weight : 160g Volume : 320ml



FMP-307

TITANIUM MUG

Made of Titanium which is the most safety material for making cutlery, and the titanium has excellent biocompatibility with human body, safe and healthy.

Product Specifications

Size : Ø74×82mm Weight : 55g Volume : 330ml

FMP-25P

PORTABLE FRETSAW



Product Specifications

Specs : 600mm Weight : 20g

Made of stainless steel wire with strong elasticity, also it is a survival tool in outdoors. It can be fold in a small volume, easy to carry and operate.

FMC-20P

POT GRIPPER

Made of aluminum. Tuck it away inside your cook set and use it well.

Product Specifications

Specs : 124×35×35mm Weight : 45g





FMP-709

FIRE STARTER



FMS-701

ADAPTOR

Made of Zinc and nylon material. Fits to 220g gas cartridge. Connect the 220g cartridge to the stoves to instead 230g gas cartridge.

Product Specifications

Specs : Ø37×26mm Weight : 53g



FMB-904/909

FOLDING BUCKET

Perfect for camping, fishing, boating, gardening, car washing etc. It adopts waterproof jeans, the joint is waterproof rubber processing.

Product Specifications

Specs : 247×230mm/170×195mm
Weight : 575g/235g
Volume : 9L/4L

FMP-709

FIRE STARTER

Made of Fe-Ce alloy and hardmetal, Its 3,000°C spark be easy to light fire in any weather & any altitude. It was voted one of the world's best fire starter by users.

Product Specifications

Specs : 20×11×80mm Weight : 29g



FMW-503

COLORFUL WIND-SCREEN



Made of aluminum plate with colorful oxidation, can greatly enhance the surface hard-righteous, sturdy and durable. And you can increase or reduce the number of pieces according your required.

Product Specifications

Specs : 140×600mm Weight : 112g



FMW-510

WIND-SCREEN

Made of aluminum with matt oxidation, high performance of anti-heat, wear-resistant, sturdy and durable.the steel handle can be slid and down, it's very easy to fix on the ground.

Product Specifications

Specs : 240×845mm 10pieces Weight : 277g



FMW-508

WIND-SCREEN

Made of aluminum with matt oxidation, high performance of anti-heat, wear-resistant, sturdy and durable. The steel handle can be slid and down, it's very easy to fix on the ground.

Product Specifications

Specs : 240×680mm 8pieces Weight : 225g



FMW-501

ULTRA-LIGHT WIND-SCREEN

Made of aluminum, only weight 58g, repeatedly folded without breaking, and can be fold in a little space.

Product Specifications

Specs : 150×750mm Weight : 58g



FMW-502

ULTRA-LIGHT WIND-SCREEN

Made of aluminum, only weight 90g, repeatedly folded without breaking, and can be fold in a little space.

Product Specifications

Specs : 210×750mm Weight : 90g

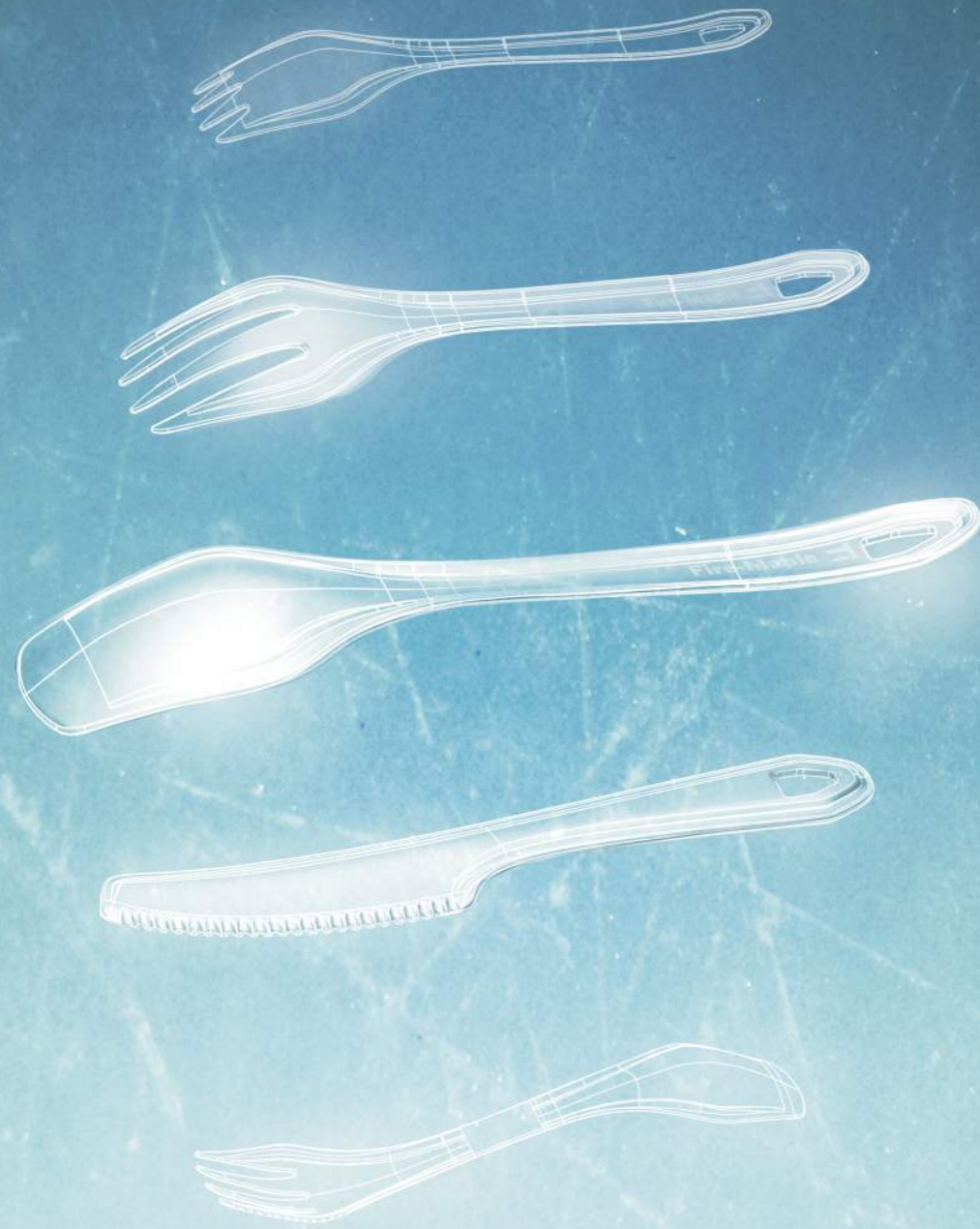

***Titanium Ultralight
Single one from only 9g.***

Dandelion Series

FIRE-MAPLE "DANDELION" CUTLERY SERIES

Designed for outdoor lovers, of which the lightest one is weight 9g only.
Made of 99.7% titanium and food grade stainless steel, safety and non-toxic,
The whole series not only contains knife, fork and spoon, but also including 3 in 1 design.
Top grade material care about your health.
Humanized design brings you comfortable hand feeling and convenient to use.



FMT-T10

TITANIUM FOLDING SPORK

Ultralight & durable. Made of titanium and come with a convenient folding handle.

Product Specifications

Specs : 155×37mm 85×37mm Weight : 17g



FMT-T18

TITANIUM SPORK

Made of Titanium. Ultra light and only 10.8g. Smart and easy to carry out.

Product Specifications

Specs : 116×40×0.8mm Weight : 10.8g



FMT-T19

TITANIUM SPORK

Made of Titanium. Light and healthy, has the function of fork and spoon. Matt surface help to avoid nick and fingerprint, easy to clean. It's the best choice of outdoor lovers who are in pursuit of lightweight equipments.

Product Specifications

Specs : 133×36×1.0mm Weight : 11g



FMT-T20

TITANIUM FORK

Made of Titanium. Light and healthy, Perfect shape and curves, can be used with titanium spoon and titanium knife. Matt surface help to avoid nick and fingerprint, easy to clean. It's the best choice of outdoor lovers who are in pursuit of lightweight equipments.

Product Specifications

Specs : 133×36×1.0mm Weight : 10g



FMT-T21

TITANIUM SPOON

Made of Titanium. Light and healthy, Perfect shape and curves, can be used with titanium fork and titanium knife. Matt surface help to avoid nick and fingerprint, easy to clean. It's the best choice of outdoor lovers who are in pursuit of lightweight equipments.

Product Specifications

Specs : 133×36×1.0mm Weight : 11g



FMT-T22

TITANIUM KNIFE

Made of Titanium. Light and healthy, Perfect shape and curves, can be used with titanium fork and titanium spoon. Matt surface help to avoid nick and fingerprint, easy to clean. It's the best choice of outdoor lovers who are in pursuit of lightweight equipments.

Product Specifications

Specs : 133×36×1.0mm Weight : 9g



FMT-T23

THREE-IN-ONE TITANIUM CUTLERY

Made of Titanium. Light and healthy, has the function of fork and spoon and knife. Matt surface help to avoid nick and fingerprint, easy to clean. Ergonomic design makes comfortable holding feel. The blade and prongs are made by accurate datum, convenient to use and not hurt people. It is a fork & spoon & knife rolled into one, and It's the best choice of outdoor lovers who are in pursuit of lightweight equipments.

Product Specifications

Specs : 165×36×1.0mm Weight : 22g





FMT-831

THREE-IN-ONE S/S CUTLERY

Made of 304# stainless steel with Mirror-surface. Ergonomic design makes comfortable handing. The blade and prongs are made by accurate datum, convenient to use and not hurt people. Easy to clean. It is a fork & spoon & knife rolled into one, and it's the best choice of outdoor lovers who are in pursuit of lightweight equipments.

Product Specifications

Specs : 165×36×1.0mm Weight : 36g



FMT-832

S/S SPORK

Made of 304# stainless steel with Mirror-surface. It is a fork & spoon rolled into one. Ergonomic design makes sure comfortable handing. Easy to clean.

Product Specifications

Specs : 165×36×1.0mm Weight : 26g



FMT-833

S/S FORK

Made of 304# stainless steel with Mirror-surface. Ergonomic design makes sure comfortable handing. Easy to clean.

Product Specifications

Specs : 165×36×1.0mm Weight : 23g



FMT-835

S/S KNIFE

Made of 304# stainless steel with Mirror-surface. Ergonomic design makes sure comfortable handing. The blade and prongs are made by accurate datum, convenient to use and not hurt people. Easy to clean.

Product Specifications

Specs : 165×36×1.0mm Weight : 19g



FMT-836

S/S SPOON

Made of 304# stainless steel with Mirror-surface. Ergonomic design makes sure comfortable handing. Easy to clean.

Product Specifications

Specs : 165×36×1.0mm Weight : 27g



FMT-803

S/S CUTLERY SET

Made of S/S, the folding design can be easy to carry. This set is including the spoon, fork and knife.

Product Specifications

Specs : 161mm / 95mm(After Folding) Weight : 80g



FMT-806

S/S FOLDING SPORK

Made of stainless steel. Only weight 30g, the folding design can be easy to carry.

Product Specifications

Specs : 157mm / 90mm(After Folding) Weight : 30g



BD-130

S/S CUTLERY SET

Made of 304 stainless steel, safe and healthy. The round hole of handle can be used as tool if needed.

Product Specifications

Spoon : 162×35×2mm 26g
Fork : 165×22×2 mm 20g
Knife : 185×16×2 mm 30g
Weight : 76g

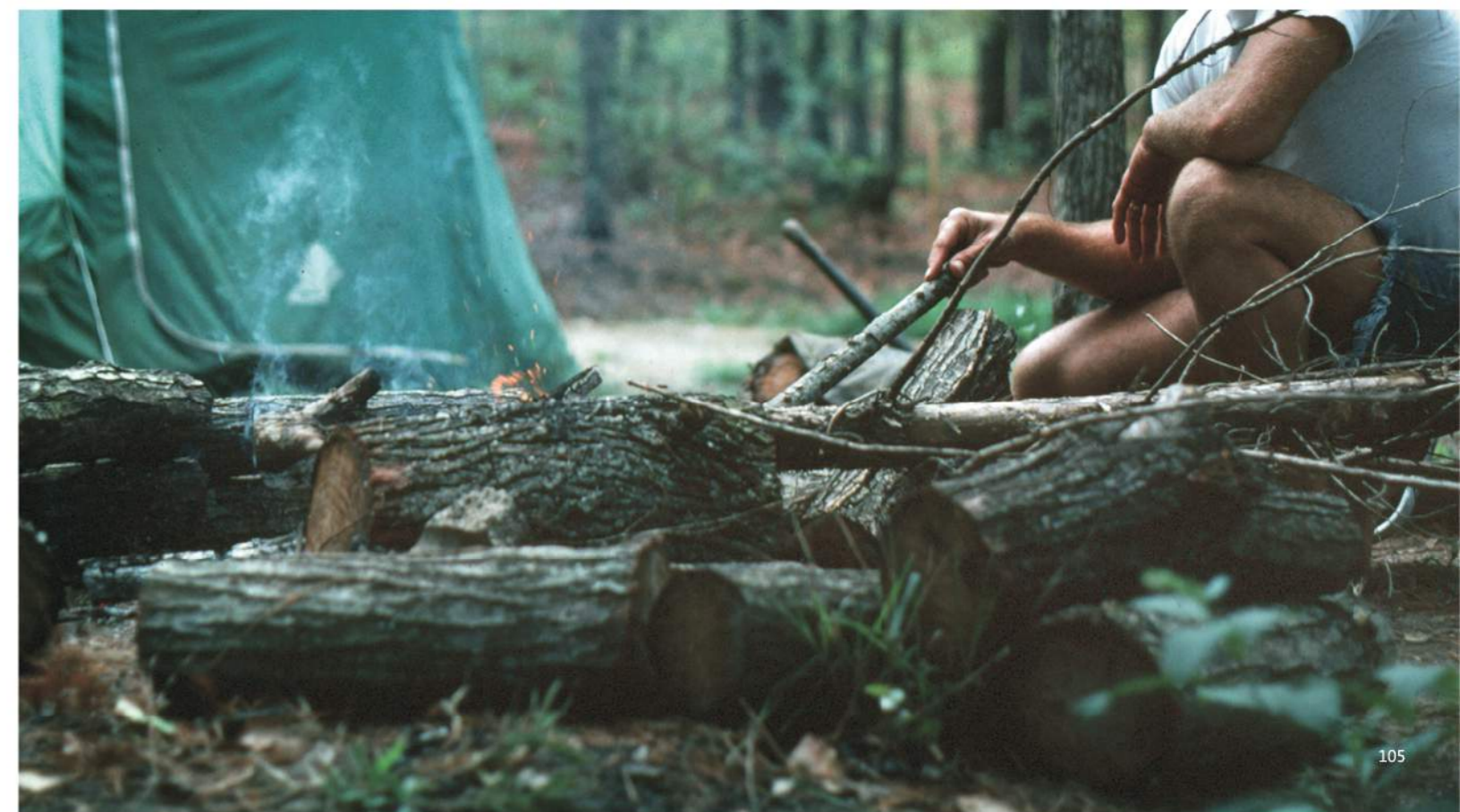

ERGATE 

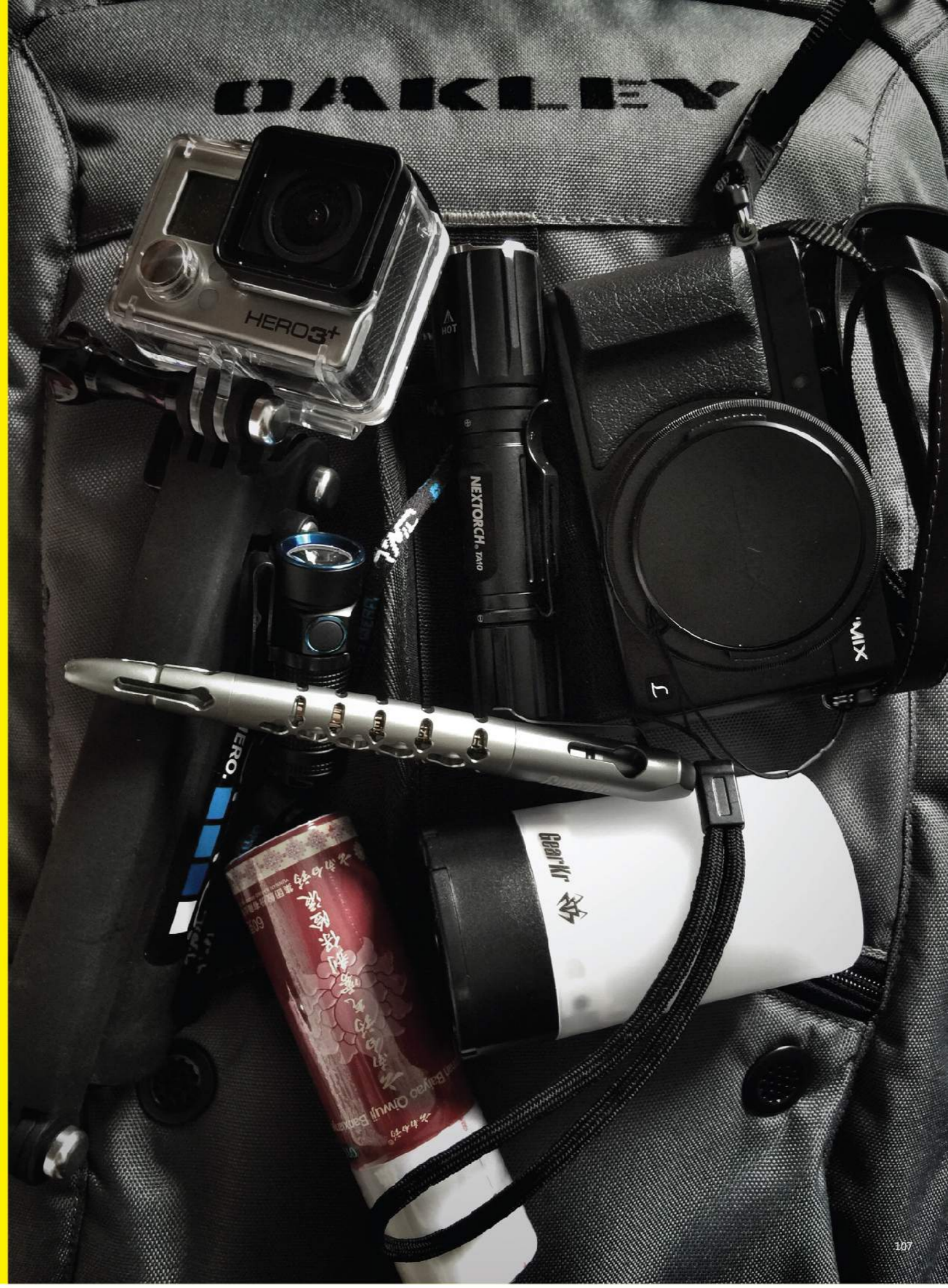



Cube Quick Charging Lantern

Cube have a magical Allay Grief Grocery Store. No matter what doubts and troubles, you can get in. The hanging lights is the switch to open your heart. You will get answers to your questions when you turn around it. Every doubt, Cube will listen patiently. It will tell you where you are right or wrong with the changing brightness.



product photo



> 9 pieces high power 5050 LED

Cube Quick-Charging Lantern

It can be fully charged for 4 pieces of Iphone6s with choosing 9 pieces high power 5050 led and 6 pieces 10800mAh, Polymer Lithium Battery. The input and output all reach 5.0V/2.0A, so the charged cell phone will get double efficiency and high rate supplementary. Extending the design of Rotary Dimmer, hiding towering switch, so that the mode will adjust more accurate and interesting. It can avoid the loss of energy from the mistakenly touching with lock function. Inside with strong magnetic and 1/4 camera screw-thread connector and bring own ring, all these make Cube unlimited possible to fit the use environment.

Mobile Power Function
 Input: DC 5.0V/2.0A
 Output: DC 5.0V/2.1A
 Rotary Dimmer
 Lock Function
 Three speed brightness
 360° Lighting without blind area
 Connect with three spiders
 Magnetic connection function
 Waterproof level IPX4

Product Name: Cube Quick-Charging Lantern
Specification: 59.6 x 59.6 x 107.2 MM
Light Source: 9 pieces high power 5050 led
Color Temperature: 3500K
Battery: 10800mAh, Polymer Lithium Battery
Lighting Area: 30m²
Lighting Time: 1 Speed 400lm-15h
 2 Speed 160lm-35h
 3 Speed 60lm-135h
Way of Adjustment: Rotary Switch → 1 → 2 → 3 → OFF, with lock function
Input: DC 5.0 V/2.0 A Micro USB
Output: DC 5.0 V/2.1 A USB
Chargeable Time: 6.5h
Using Temperature: -30°C — +60°C
International Industry Waterproof Level: IPX4

Material: LEXAN ABS
Weight: 360g (Including Polymer Lithium Battery)
Place of Origin: China
Suitable: Daily & Camping



Product Introduction



About Input Output
 5.0V/2.1A
 USB Output supply electricity for outside equipment
 5.0V/2.0A Micro
 USB Input for charging lantern



Indicator Lights
 ① When the indicator lights light up, it means it begins to output electricity
 ② When the indicator lights begin to go out step by step, it means the decrease of the electricity
 ③ When the indicator lights is twinkling, it means the charging is beginning
 ④ When the 4 indicator lights all light up, it means the electricity is full charged.
 ⑤ When the 4 indicator lights begin to twinkle in the same time, it means the chargeable electricity is finished.



Various Use Environment
 ① Flat
 ② Hanging
 ③ Surface of indicator lights absorb Fe
 ④ Connect with three spiders

Wali



"Wali" Headlamp is suitable for using by professional outdoor people. It has two Optical System with Spotlight and Floodlight which make it can change quickly in the action and reduce the dangerous bringing by the complex geography. It can reach the unlimited dimmer when you press down the button gently. "Wali" get well balance between the weight, brightness, easy operation and long time for battery life which all these make it suitable for the needs → using of perfect outdoor activities.

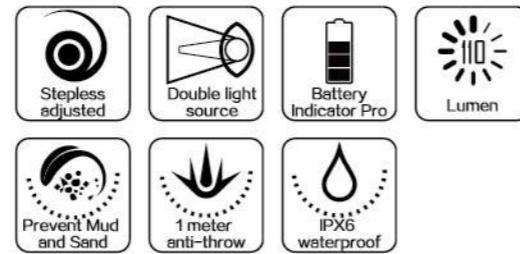

product photo



> Brightness and Time: 110 Lumens—5.5h / 5 Lumens—80h, International Industry Waterproof Level: IPX6

Wali



Two Optical System of Spotlight and Floodlight
 Constant High Lighting
 Warnings of the battery reserves
 Long time for pressing the unlimited dimmer
 Twinkle Model
 Touch-resistance with lock functions
 High elasticity ventilate sweatland
 Waterproof Level IPX6

Product Name: Wali
 Specifications: 66×43×33mm
 Light Source: 2×CREE xpe
 Color Temperature: 6000 K
 Light-dimmer Model: Long time for pressing the unlimited dimmer
 Brightness and Time: 110 Lumens—5.5h / 5 Lumens—80h
 Light way: Spotlight—Floodlight
 Irradiation Distance: Spotlight 100m/Floodlight 35m
 Battery: 3 pieces of AAA ALK Battery or NiMH Rechargeable Battery
 International Industry Waterproof Level: IPX6
 Using Temperature: -30°C — +60°C

Material: LEXAN ABS, Polyester
 Weight: 62g(Net), 98g(Gross, including the battery)
 Place of Origin: China
 Suitable: Extreme outdoor activities



Tropical Orange



Starry Night Blue

Product Introdycyion

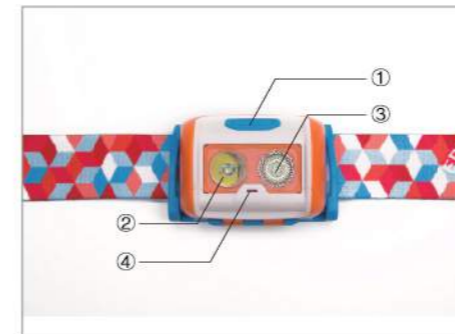

- ① ON/OFF
- ② Creepe Long shot
- ③ Battery percent indicator
- ④ Creepe diffuse light



Alternative flashing
 In OFF mode, double tap the switch quickly to turn on alternative flashing mode.



Put in 3 AAA batteries
 Please use AAA alkaline batteries or NiMH rechargeable batteries.
 DO NOT mix batteries of different brands or models.
 DO NOT mix old and new batteries.



Brightness and Time: 70 Lumens—3.5h / 5Lumens— 50h, International Industry Waterproof Level: IPX6

Minions

“Minions” Headlamp is simple, stable and efficient. Lovely appearance, but has a —with hiding two strong power of lighting core. The unlimited dimmer make it much more easy for operating. “Minions” Headlight has become the top choice for beening needed by the professional climber in the nighttime.

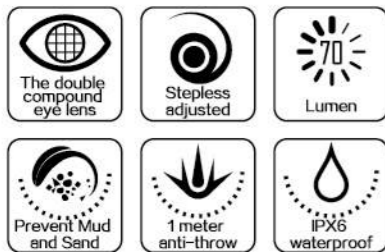

Minions

Long time for pressing the unlimited dimmer
 Double compound eye lens
 Efficient circuit
 Low power for long time standby → Constant High Lighting
 Waterproof Level IPX6

Product Name: Minions
 Specifications: 67×34×33mm
 Light Source: 2×samsung2323
 Color Temperature: 6000 K
 Light-dimmer Model: Long time for pressing the unlimited dimmer
 Brightness and Time: 70Lumens—3.5h
 5Lumens— 50h
 Light way: Floodlight
 Irradiation Distance: Floodlight 40m
 Battery: 2 pieces of AAA ALK Battery or NiMH Rechargeable Battery
 International Industry Waterproof Level: IPX6
 Using Temperature: -30℃— +60℃

Material: LEXAN ABS, Polyester
 Weight: 52g(Net), 76g(Gross, including the battery)
 Place of Origin: China
 Suitable: Leisure Travel



Product Introdycion

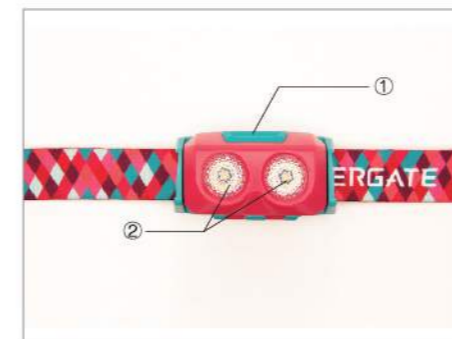

- ① ON/OFF
- ② 2xSamsung2323 Floodlight



Constant current module
 Minions headlamp applies high efficient constant current circuit. Electricity is output constantly until less than 25% is left. Then switching to inconstant current state to extend battery life and promote performance. Stand-by power consumption of Minions headlamp is only 8μA.



Put in 2 AAA batteries
 Please use AAA alkaline batteries or NiMH rechargeable batteries. DO NOT mix batteries of different brands or models. DO NOT mix old and new batteries.



White



Orange



Coral Blue

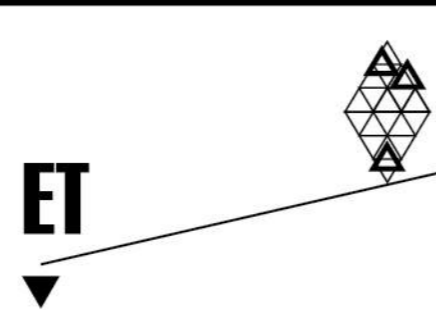

ET

Reserved 8 years of the Battery
Efficient circuit
Five Speed for the lighting model
NICHIA 5mm Bright White LED
NICHIA 3mm Bright Red LED
25m of the lighting distance
Waterproof Level IPX7

Product Name: ET
Specifications: 45×35×20mm
Light Source: 2 pieces NICHIA 5mm White LED
1 piece NICHIA 3MM Red LED
Color Temperature: 5000 K
Light-dimmer Model: Five adjustments for lighting
Brightness and Time: 18 Lumens (White) — 15h
6 Lumens (White) — 50h
5 Lumens (Red) — 62h

Light way: Spatlight
Irradiation Distance: Spotlight 25m max
Battery: 2 pieces CR2032 Button Lithium Battery
International Industry Waterproof Level: IPX7
Using Temperature: -30℃— +60℃

Material: LEXAN ABS, Polyester
Weight: 31g (Net) , 37g (Gross, Including the battery)
Place of Origin: China
Suitable: Daily &Camping

Product Introdycion

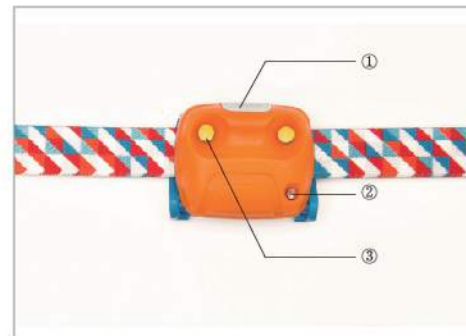

- ① ON/OFF
- ② Highlight red LED
- ③ Highlight white LED



Unscrew the battery lid with fastening on the ribbon.
Screw the battery lid with fastening on the ribbon.



About battery
Please use CR2032 button lithium batteries.
DO NOT mix batteries of different brands or models.
DO NOT mix old and new batteries.

product photo



> Brightness and Time: 18 Lumens (White) — 15h / 6 Lumens (White) — 50h / 5 Lumens (Red) — 62h

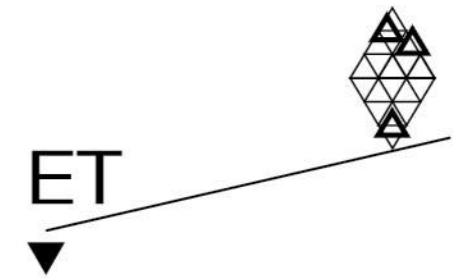

“ET” is a lightweight and easy-carry headlamp with reserving 8 years of the battery, which make “ET” can keep enough energy to deal with the unexpected dilemma. The irradiation distance can reach the surprised 2m, only weight 37g that is the best suitable for taking along as the spare light source.

| | | | |
|--|--|--|--|
| | | | |
| | | | |